

DEPARTMENT OF COMMERCE
BUREAU OF STANDARDS
George K. Burgess, Director

TECHNOLOGIC PAPERS OF THE BUREAU OF STANDARDS, No. 265
[Part of Vol. 18]

THEORY AND PERFORMANCE OF RECTIFIERS

BY

H. D. HOLLER, Chemist
J. P. SCHRODT, Associate Physicist
Bureau of Standards

October 9, 1924



PRICE, 20 CENTS

\$1.25 PER VOLUME ON SUBSCRIPTION

Sold only by the Superintendent of Documents, Government Printing Office
Washington, D. C.

WASHINGTON
GOVERNMENT PRINTING OFFICE
1924

THEORY AND PERFORMANCE OF RECTIFIERS

By H. D. Holler and J. P. Schrodt

ABSTRACT

The purpose of this investigation was (1) to determine the performance of the various types of rectifiers used for charging batteries and (2) to present the theoretical principles on the basis of which their performance may be explained. The rectifiers studied included an aluminum and a tantalum electrolytic rectifier, two thermionic or ionized gas rectifiers, and five of the magnetic vibrating type.

For the measurement of rectified current it was found by means of a copper coulometer that an ammeter of the D'Arsonval type indicates the average value of any rectified current. The ratio of the average value to the root mean square value of the rectified current is a measure of the completeness of rectification. This ratio is called "the degree of rectification."

A considerable portion of this work was devoted to the electrolytic rectifier because of its suitability for studying the effects of various factors upon wave form and rectification. The degree of rectification of the electrolytic rectifier increases with current density used on the rectifying electrode and also with the amount of inductance in the circuit. It is reduced by increasing the frequency, the temperature, and the number of cells being charged. The energy efficiency of the electrolytic rectifier is increased by reducing the line voltage with a series reactance or with a transformer.

The performance of the thermionic and the vibrating rectifiers was determined at different battery voltages. The curves representing the variation of power output and efficiency with battery voltage show well-defined maxima as would be expected from theoretical considerations. The battery voltage at which maximum power output is obtained is practically the same voltage as that at which the rectifiers are rated by the manufacturers.

The efficiency of the vibrating rectifiers was determined over a considerable range in frequency and line voltage as well as battery voltage and an explanation of the variations in their performance under different conditions is given.

The effects of various factors on rectification are demonstrated by means of numerous oscillograms and diagrams as well as performance curves.

CONTENTS

| | Page |
|---|------|
| I. Introduction..... | 466 |
| II. General characteristics of electrolytic rectifiers..... | 466 |
| III. Description of the aluminum rectifier..... | 467 |
| IV. Theory of electrolytic rectification..... | 471 |
| V. Electrolytic rectifier in series with a battery..... | 479 |
| VI. Electrolytic rectifier in series with inductance..... | 481 |
| VII. Electrolytic rectifier in series with an iron core inductance..... | 489 |
| VIII. Performance tests of an aluminum rectifier..... | 489 |
| IX. Description of the tantalum rectifier..... | 497 |
| X. Performance tests of a tantalum rectifier and theoretical derivation of relation between output and battery voltage..... | 501 |
| XI. Description of the thermionic rectifier..... | 503 |
| XII. Performance tests of thermionic rectifiers..... | 504 |
| XIII. Description of vibrating rectifiers..... | 508 |
| XIV. Performance tests of vibrating rectifiers..... | 510 |
| XV. Summary..... | 526 |

I. INTRODUCTION

During the last few years the demand for small rectifiers has grown rapidly. This growth has been due to the increasing use of small portable batteries and also to the increasing practice of using low rates for charging larger batteries. This latter method of charging is called "trickle charging" and requires a small current to maintain the battery in a charged condition. Because of this small current requirement and the general availability of alternating-current power, rectifiers of small output are extensively used.

For larger amounts of direct-current power, of course, the use of synchronous converters, motor-generator sets, and the mercury-arc rectifiers are too well known to require further attention here. Very little published information on the smaller rectifiers is available. Because of this lack of information and also because of the demand for data on the performance of various types of rectifiers, this paper was prepared. It includes a discussion of the principles underlying the operation of rectifiers.

The rectifiers which were studied include several aluminum and tantalum rectifiers, thermionic or ionized gas rectifiers, and several of the vibrating type. They are discussed here in the order named.

Since the use of rectifiers is nearly always for charging batteries, the tests were made under various conditions during the charging of a battery. The theory of rectification presented, therefore, takes into account the presence of a counter electromotive force. Because of the suitability of the electrolytic rectifier for developing the theory of rectification and for studying the effect of various factors upon rectification, it is discussed at considerable length. A more important reason, however, is the possibility of further development and use of the electrolytic rectifier.

II. GENERAL CHARACTERISTICS OF ELECTROLYTIC RECTIFIERS

It has long been known that certain metals when used as an electrode in a suitable electrolyte offer a high resistance to the flow of current from electrode to electrolyte, but practically no resistance to the current flowing in the opposite direction. The direction of current is here used in the ordinary sense; that is, opposite to the flow of electrons. Such a metal acts as a check valve in an alternating-current circuit. An electrolytic rectifier consists

essentially of a "valve" metal as one electrode, a suitable electrolyte, and another electrode which will permit the current to flow readily in either direction.

A considerable number of metals possess this valve effect (among them being aluminum, tungsten, tantalum, bismuth, magnesium, and others), but only two of them have been successfully used in practice as electrolytic rectifiers, namely, aluminum and tantalum. While the theory of electrolytic rectification applies equally to both of these metals, most of the published information relates to aluminum, which has been the subject of many investigations since the early observations of Buff¹ and Wheatstone.² Tantalum has only recently come into practical use as a rectifier.

Because of its low efficiency and the careful attention required for its successful operation, the aluminum rectifier has been of little practical use. For charging small batteries, such as radio B batteries, where only a few tenths of an ampere are required, the aluminum rectifier is cheap and simple to construct, and for those who are willing to give it the necessary attention it may be used with satisfactory results.

For charging larger batteries, where a rate of several amperes is required, the tantalum rectifier is better adapted. It has the advantage over the aluminum rectifier of being more resistant to the corrosive action of the electrolyte, and consequently has a longer life. Because of its high resistance to corrosive action, it permits the use of higher current densities.

III. DESCRIPTION OF THE ALUMINUM RECTIFIER

The electrolytes which have been found satisfactory for aluminum rectifiers are, in general, solutions of one or more of the ammonium and alkali salts of some of the weak acids, such as the borates, tartrates, phosphates, oxalates, citrates, and carbonates. Unfortunately, most of them have a low conductivity. Since small amounts of some of the strong acids and heavy metals accelerate deterioration of the aluminum electrode, it is necessary that the electrolyte and electrodes be free from these impurities. Small amounts of the halides are particularly deleterious.³ Fused salts have also been used.⁴

¹ Buff, *Liebig Ann.*, **102**, p. 269; 1857.

² Wheatstone, *Phil. Mag.* (4), **10**, p. 143; 1855.

³ Schulze, *Z. f. Elektrochem.*, **20**, p. 307; 1914.

⁴ Burgess and Hambuechen, *Trans. Am. Electrochem. Soc.*, **1**, p. 147; 1902.

The electrodes used opposite the aluminum are usually lead, iron, or carbon. In some cases the cell container has been made of lead or iron, which also served as electrode.

For charging small storage batteries at the rate of several tenths of an ampere we have found a solution of sodium acid tartrate, ammonium phosphate, or common borax quite satisfactory, using a carbon rod and an aluminum wire, which was frequently renewed. If battery carbons are used, care should be taken to remove all traces of salts from the carbon. One of these rectifiers, using a 10 per cent solution of ammonium phosphate and giving 0.2 or 0.3 ampere, ran for several hundred hours on continuous service.

Because of the poorly conducting electrolyte and the high resistance of the oxide film, the I^2R loss in the aluminum rectifier is considerable. As will be shown later, a high degree of rectification can be obtained only by using a high-current density. This means that the I^2R heat is limited to a small space and results in a considerable rise in temperature. A rise in temperature may increase the rate of deterioration of the oxide film and result in poorer rectification. It is, therefore, necessary to keep the temperature as low as possible. With this in view, various shapes and sizes of electrodes and containers have been designed to provide maximum cooling, including provisions for water cooling.⁵ Usually sufficient cooling may be obtained by using a large volume of electrolyte as compared with the size of the electrodes.

It has long been known that aluminum, when used as anode in a suitable electrolyte, forms a film on its surface which offers a high resistance to the flow of current. Thus, if a cell consisting of aluminum as anode and lead as cathode in a solution of borax be subjected to a constant electromotive force, a current will flow, but will quickly drop to a relatively low value. The time required for the current to drop to a constant low value depends upon the rate at which the film of oxide is formed.

The formation of the oxide film by direct current when an electromotive force of 25 volts was impressed upon an aluminum anode having an area of about 1 cm² occurred almost instantly. The oscillogram in Figure 1 shows the rate at which the current was

⁵ Electrician, 73 (supplement), pp. 124-125, 1914; Elektrochem., Z., 19, p. 11, 1912.

reduced to almost zero within a period of three seconds. On an area of 300 cm² the formation of film was so slow that even when 120 volts direct current were applied complete formation of the film required several hours. The thickness of the film depends upon the area of the electrode, the time, and the voltage applied. On increasing the impressed voltage a point is finally reached where sparking occurs between the anode and the electrolyte. This is referred to as the maximum voltage and may amount to 400 or 500⁶ volts. It is this property which has been employed in the construction of the electrolytic lightning arrester.

If the aluminum be made cathode, current will flow and continue to flow so long as the applied electromotive force is above a certain minimum value. In this case, therefore, the film on the surface of the aluminum offers only a small resistance to the flow of current.

The difference between the behavior of the aluminum as anode and as cathode is usually explained by the statement that the apparent resistance of the film is enormously greater when it is an anode than when it is cathode. The exact reason for such difference in resistance is not completely understood. Some authors claim that the apparent high resistance



FIG. 1.—Formation of oxide film by direct current
Total time about three seconds

⁶ Coulson, U. S. Patents 1225391, 1390505, 1412514.

of the anode film is a counter electromotive force⁷ while other experimental evidence indicates that the resistance is ohmic in nature. The theory regarding the nature of the film most commonly referred to is that

of Schulze⁸ who believes that the film on the aluminum electrode consists of a porous layer of oxide or hydroxide partially filled with gas, which is impermeable to all ions except those of hydrogen. When the aluminum is cathode according to Schulze's theory, the hydrogen ions are able to penetrate the film and be discharged at the surface of the metal. The film, therefore, permits the flow of electrons from, but not to the electrode.

If an alternating voltage be applied to an aluminum cell, an oxide film also forms and its rate of formation depends upon the voltage used. The oscillogram in Figure 2 shows the formation of the film which was completed within about 15 seconds under conditions otherwise similar to those used in obtaining the oscillogram in Figure 1.

An aluminum rectifier when not in continuous use loses its rectifying

power for the reason that the oxide film is impaired by the chem-

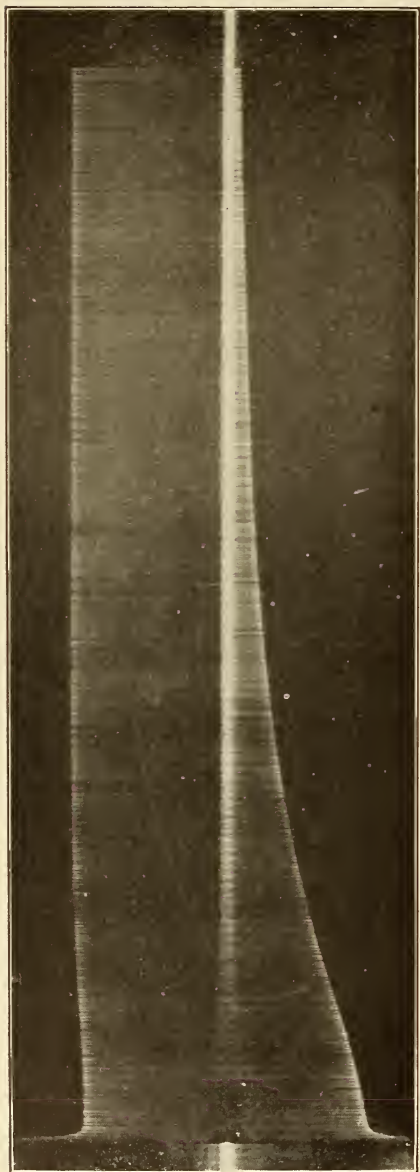

FIG. 2.—Formation of oxide film by alternating current

Total time about 15 seconds

⁷ Cook, *Phys. Rev.*, **18**, p. 23; 1904; **20**, p. 312; 1905. Fitch, *Phys. Rev.* (2), **9**, p. 15; 1917. Greene, *Phys. Rev.* (2), **3**, p. 264; 1914. Guthe, *Phys. Rev.*, **15**, p. 327; 1902.

⁸ *Trans. Faraday Soc.*, **9**, p. 266; 1913. *Zeit. f. Elektrochem.*, **14**, p. 333; 1908. *Jahrbuch d. Radiakt. u. Electronik.*, **17**, p. 364; 1920.

ical action of the electrolyte. After the rectifier has been standing idle for some time it is usually necessary to re-form the film with direct or alternating current before it will rectify.

IV. THEORY OF ELECTROLYTIC RECTIFICATION

When an alternating electromotive force of sufficient magnitude is impressed upon an electrolytic rectifier with completely formed film, the half wave making the rectifying metal cathode produces a flow of current, but on the other half wave, while the

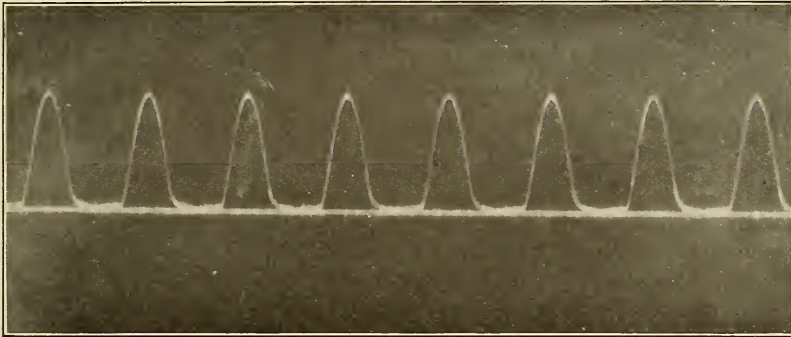

FIG. 3.—Rectified current of an aluminum rectifier having small area of electrode surface
Rectification in this case is practically complete

rectifying metal is anode, no appreciable current flows. The resultant current is, therefore, in one direction and consists of pulsations whose frequency is the same as that of the impressed electromotive force. If no counter electromotive force or induc-

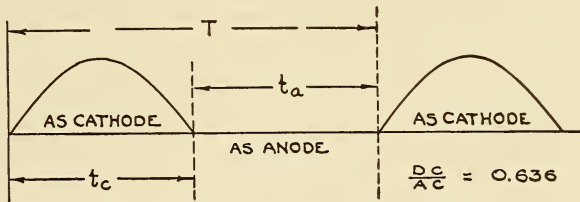

FIG. 4.—Half-wave rectification without inductance, capacity, or counter emf

T = period of one cycle,
 t_c = interval when rectifying metal is cathode,
 t_a = interval when rectifying metal is anode.

tance is in the circuit and the impressed electromotive force is sinusoidal, a wave form like that in Figure 3 is obtained for the rectified current. The pulsations of current occur when the aluminum is cathode, and this is referred to as half-wave rectification (fig. 4).

Measurement of the rectified current may be made with sufficient accuracy with a permanent magnet type of ammeter. This was determined by making some experiments in which a copper

coulometer was used in series with an electrolytic rectifier and a Weston model 1, direct-current milliammeter with a full scale of 500 milliamperes. Using a rectified current of 225 milliamperes, as indicated by the ammeter, the weight of copper deposited in the coulometer indicated a current of 224 milliamperes as an average of four determinations. This agreement was considered sufficiently good for our purpose.

Since the amount of rectification refers to the proportion of alternating current converted into direct current, the most concrete expression for this relation is the ratio of the average value of the current as measured by a permanent magnet type of ammeter to the root mean square value of current as measured by a hot wire or dynamometer type of ammeter. This ratio will be referred to as the degree of rectification and expressed as

$$\frac{DC}{AC} = \frac{\text{average value of current}}{\text{root mean square value of current}}^9$$

In the simplest ideal case of half-wave rectification represented in Figure 4

$$\frac{DC}{AC} = \frac{\int_0^\pi \frac{I_{\max} \sin \theta \cdot d\theta}{2\pi}}{\sqrt{\int_0^\pi \frac{I_{\max}^2 \sin^2 \theta \cdot d\theta}{2\pi}}} = \frac{2}{\pi} = 0.636 \quad (1)$$

The value of 0.636 is, therefore, the maximum degree of half-wave rectification obtainable when the circuit is free from inductance and counter electromotive force.

By certain combinations of rectifiers as shown in Figures 5 and 6 it is possible to rectify both halves of the wave and obtain a rectified current similar to that in Figure 7, which has a frequency twice that of the impressed electromotive force. An oscillogram in Figure 8 shows full-wave rectification with four rectifiers connected according to the method in Figure 5. In the case of full-wave rectification when there is no appreciable inductance, capacity, or counter electromotive force the ratio

$$\frac{DC}{AC} = \frac{2 \int_0^\pi \frac{I_{\max} \sin \theta \cdot d\theta}{2\pi}}{\sqrt{2 \int_0^\pi \frac{I_{\max}^2 \sin^2 \theta \cdot d\theta}{2\pi}}} = \frac{2\sqrt{2}}{\pi} = 0.905 \quad (2)$$

The theoretical maximum values of 0.636 and 0.905 may be closely approached.

⁹ The degree of rectification is sometimes expressed as a percentage which has no definite meaning unless carefully specified. The method of expressing it here as a ratio of the two observations required to obtain an exact measure of the completeness of rectification seems more desirable.

The actual operation of a single aluminum rectifier does not consist simply in cutting off one-half of each cycle, as might be implied in Figure 4, although such a curve is approximated if the impedance of the circuit is entirely resistance, and if there is no counter electromotive force present. Under these conditions the interval of time t_c that the valve is open is one-half the total period T .

During the period t_a when the aluminum is anode, no appreciable direct current flows through the oxide film, but the film acts as a dielectric between electrode and electrolyte and the whole combination operates like a condenser. The capacity of this condenser

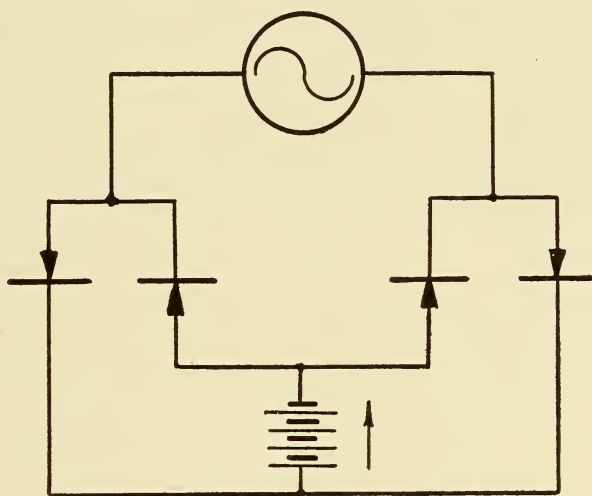

FIG. 5.—Four rectifiers for full-wave rectification

Direction of rectified current indicated

is proportional to the area of the anode in contact with the electrolyte and is from $1/20$ to $1/10 \mu\text{f}/\text{cm}^2$.¹⁰

By increasing the area of the electrode, therefore, the capacity is increased and an appreciable capacity current flows during the anodic period, leading the impressed voltage by a quarter of a cycle (fig. 9).

The electrolytic rectifier may be represented by an arrangement similar to Figure 10, in which S is a double switch operating in synchronism with the circuit. Contact through the 10-ohm resistance represents the valve when open, and contact through the 5,000-ohm resistance in parallel with a $2 \mu\text{f}$ condenser represents the valve when closed. Careful adjustment of the switch

¹⁰ Coulson, loc. cit.

contacts to give the proper time interval produced a rectified current shown by the oscillogram in Figure 11, which is almost identical with that in Figure 12 for an electrolytic rectifier. The

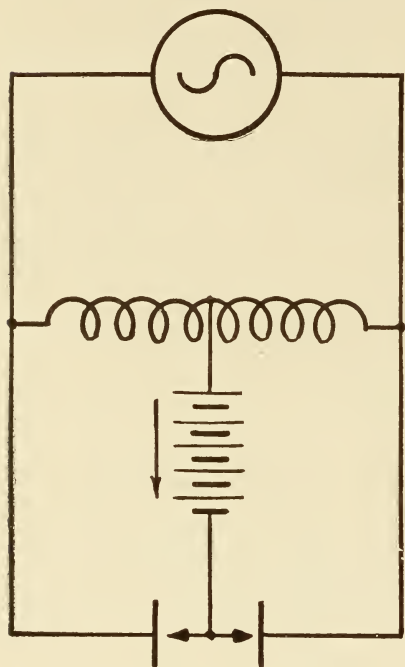

FIG. 6.—Three-electrode rectifier for obtaining full-wave rectification

Direction of rectified current indicated

ratio DC/AC is less at higher frequencies, as shown by Zenneck¹¹ and Schulze.¹²

The effect of the area of electrode and, therefore, the effect of capacity is clearly shown by comparing the oscillogram in Figure

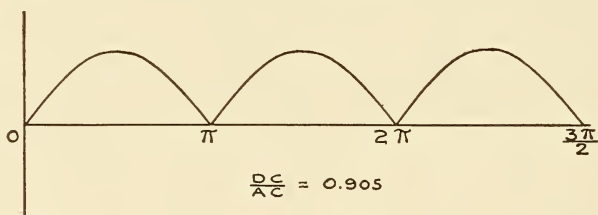

FIG. 7.—Full-wave rectification without inductance or counter emf in series with rectifier

12 for a rectifier having an aluminum area of about 20 cm² with that in Figure 3 for a rectifier with an area of less than 2 cm².

¹¹Phys. Zeit., 14, p. 535; 1913.

¹²Phys. Zeit., 15, p. 254; 1913.

The effect of a $2 \mu\text{f}$ condenser in parallel with the rectifier having a small area is shown in the oscillogram in Figure 13.

In addition to the capacity current I_C , which flows when the valve is closed, a direct current I_L , usually referred to as the

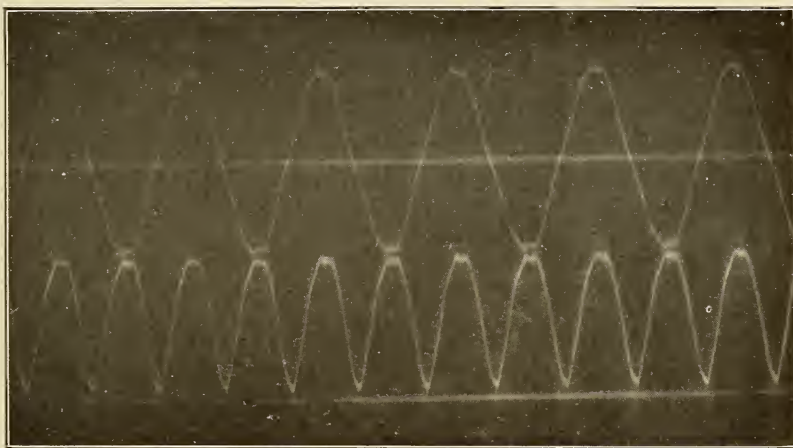

FIG. 8.—Full-wave rectification with four electrolytic rectifiers arranged as in Figure 5 with no battery

Upper curve represents impressed voltage

leakage current, also flows, its magnitude depending upon the impressed voltage, the area, and completeness of the oxide film. (See fig. 9.) The leakage current is the result of the impressed

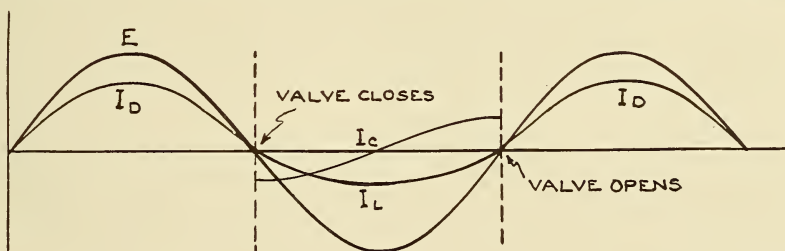

FIG. 9.—Relation between impressed voltage E , rectified current I_D , leakage current I_L and capacity current I_C in the absence of inductance and counter emf

voltage upon the high resistance of the anode film and is in phase with the impressed voltage.

When a battery is being charged the voltage impressed upon the anode film is equal to the sum of the line voltage and battery voltage. The voltage which the film must withstand, therefore, increases with the battery voltage. It is for this reason that the

leakage current increases with battery voltage, and since the leakage current tends to break down the rectifying film, the endurance of the film and also the life of the rectifier is likely to be reduced by charging too many cells. The voltage across the rec-

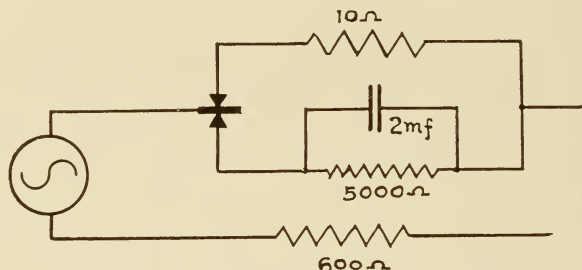

FIG. 10.—Operation of rectifier having capacity

Figure 11 is the oscillogram obtained with this circuit

tifier is, therefore, very much greater when the valve is closed than when it is open. The oscillogram in Figure 14 shows considerable leakage current without an appreciable capacity current, while that in Figure 15 shows both a leakage current and a

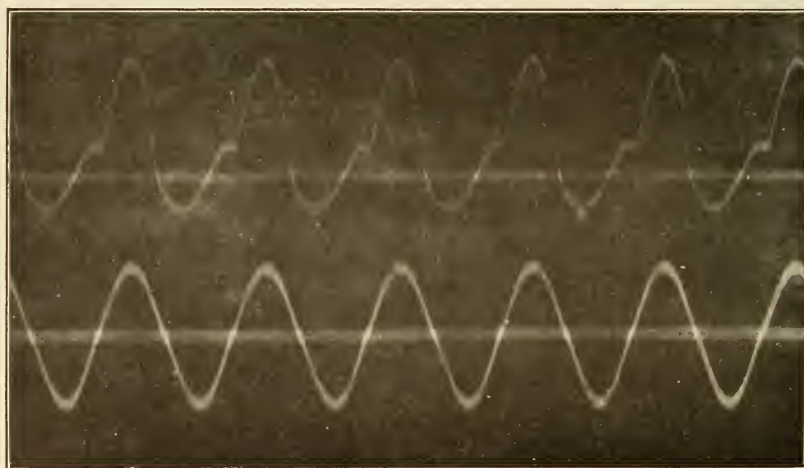

FIG. 11.—Rectified current with synchronous switch as shown in Figure 10

Lower curve represents impressed voltage

capacity current. The capacity current leads the impressed electromotive force by a quarter of a cycle, but the leakage current is in phase with the applied voltage.

Since the values of I_L and I_C both decrease with reduction of anode area, the theoretical value for DC/AC (0.636) may be practi-

cally attained if the electrode area is made very small and the impedance of the circuit consists entirely of resistance. In other words, for maximum rectification the current density must be

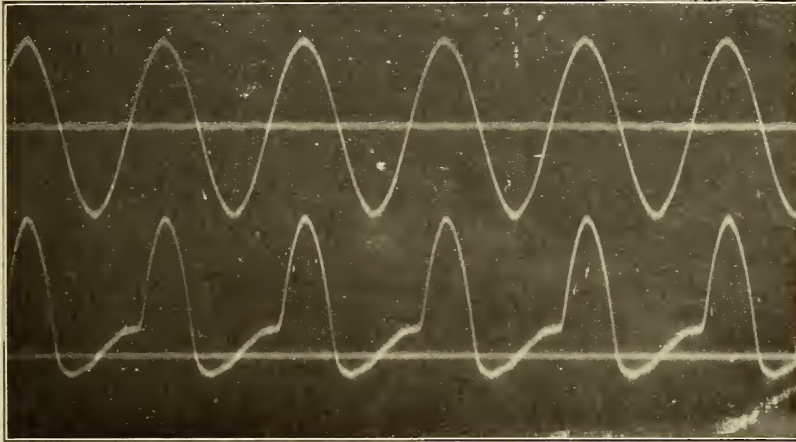

FIG. 12.—Rectified current of an aluminum rectifier having large area of electrode, and showing the capacity current

Upper curve represents the impressed voltage. Note similarity to Figure 11

high. The results of Zenneck given in Figure 16 show the effect of current density upon the degree of rectification for frequencies of 50, 4,000, and 10,000 cycles for an aluminum rectifier with an

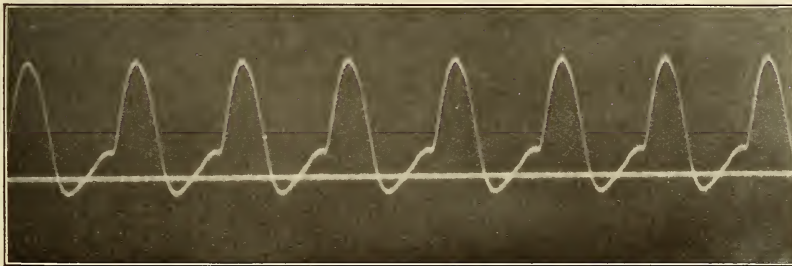

FIG. 13.—Rectified current of same rectifier as shown in Figure 3, having a 2 mf condenser in parallel

Note the capacity current

area of 3.1 cm². Thus, at high frequencies the current density must be considerably higher than at lower frequencies to obtain any appreciable rectification.

While the degree of rectification is higher at the higher current densities, the I^2R loss is concentrated on a smaller area and the temperature of the rectifier is thereby increased. Rise in tem-

perature results in more rapid deterioration of the oxide film and consequently poorer rectification and less endurance. Attempts

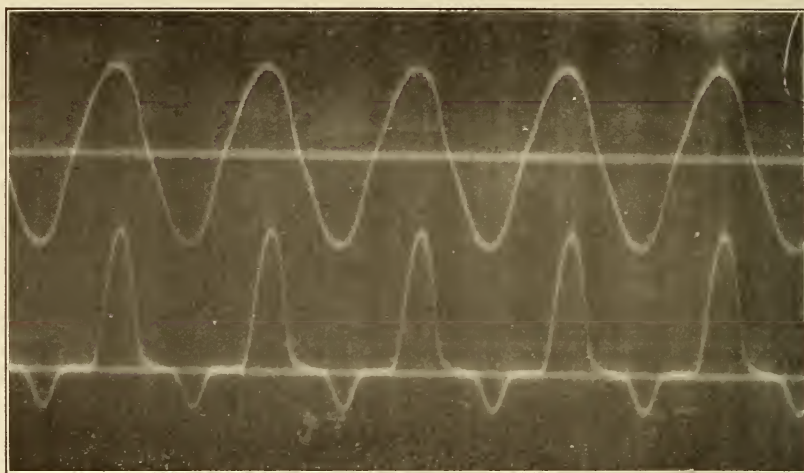

FIG. 14.—Rectification with an aluminum rectifier showing leakage effect

The upper curve represents the impressed voltage

to produce a practical electrolytic rectifier have been directed mainly toward the prevention of a harmful rise in temperature,

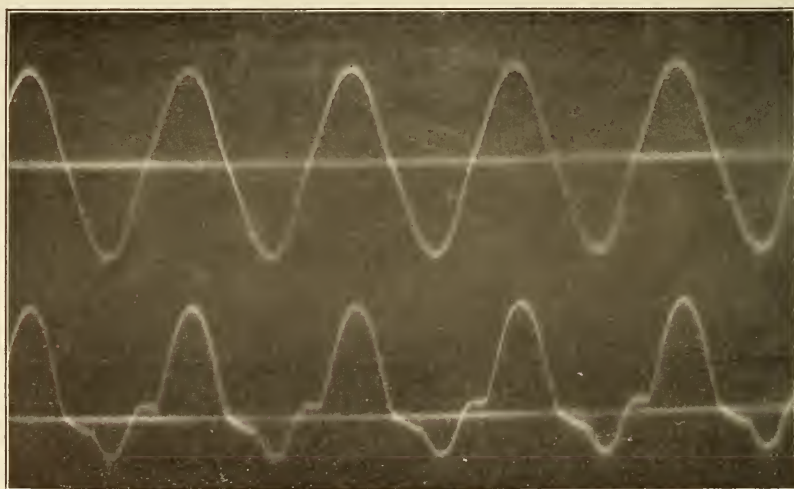

FIG. 15.—Rectification with an aluminum rectifier showing both leakage and capacity effect

Upper curve represents impressed voltage

and have resulted in various shapes and sizes of electrodes and containers to produce maximum cooling effect.

V. ELECTROLYTIC RECTIFIER IN SERIES WITH A BATTERY

In order to charge a battery the rectifying electrode must be connected to the positive terminal of the battery as in Figure 17 and the direction of the pulsating direct current will be as indi-

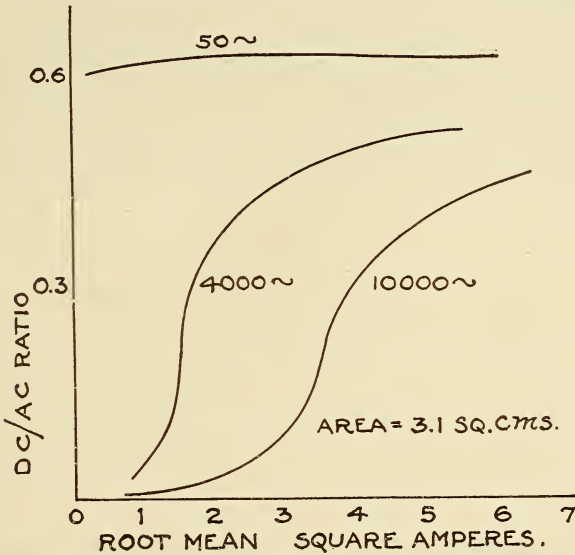

FIG. 16.—Zenneck's curves showing relation between current and degree of rectification at different frequencies

cated. The impressed emf must exceed the sum of the battery voltage and counter emf of the rectifier to obtain any rectification. If the impressed voltage is less than this sum, only a capacity

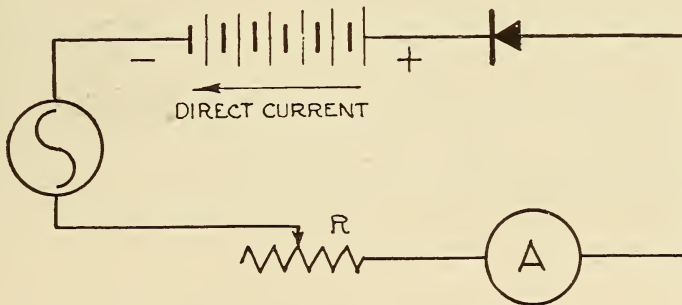

FIG. 17.—Proper connection of battery to rectifier

current is obtained as is the case in Figure 18. When the applied emf slightly exceeds the counter emf of the battery and rectifier, a slight rectification is obtained, as can be seen by the appearance of a small peak in phase with the voltage. (See fig. 19.)

When the applied emf considerably exceeds the total counter emf a rectified current of the usual wave form is obtained as in Figure 12. In the case of these three oscillograms a 24-volt storage bat-

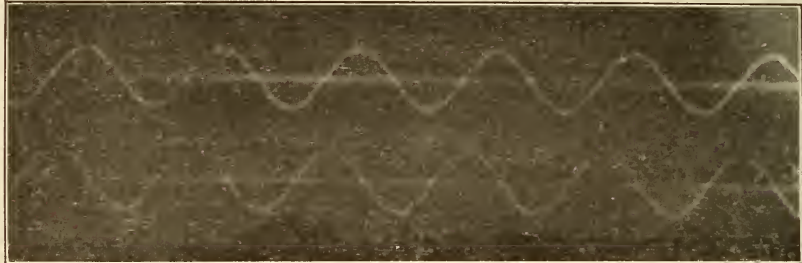

FIG. 18.—Oscillogram showing the capacity current (lower curve) obtained when the impressed voltage is less than the combined battery voltage and counter emf of electrolytic rectifier

Upper curve represents impressed voltage

tery was used, and the applied voltage was 28, 48, and 60 volts, respectively.

The counter emf of the rectifier when the aluminum is cathode is called the minimum potential (Mindestspannung) by Schulze, and amounts to 2 or 3 volts.

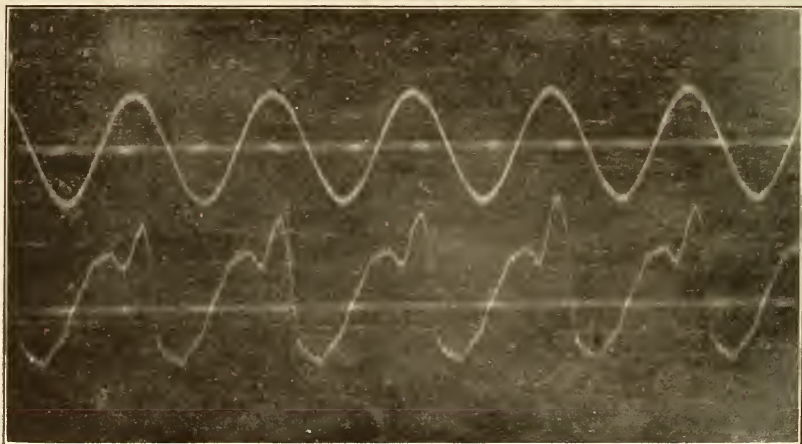

FIG. 19.—Impressed voltage is slightly greater than the total counter emf of battery and rectifier

Note appearance of rectified "peak" in phase with the voltage. Upper curve represents voltage

If the impressed voltage $= E_{\max} \sin(\omega t - \alpha)$, the battery voltage $= E_B$, and the counter emf of rectifier $= E_R$, then no rectified current will flow until $E_{\max} \sin(\omega t - \alpha) > E_B + E_R$. These voltage relations are shown in Figure 20, where it is apparent that the

rectified wave is really less than a half cycle in length. If for example,

$$E_B + E_R = \frac{1}{2} E_{max}$$

then, when $t = 0$

$$\sin \alpha = \frac{E_B + E_R}{E_{max}} = \frac{1}{2} \text{ or } \alpha = 30^\circ \tag{3}$$

The valve would then be open, $180^\circ - (2 \times 30^\circ)$ or 120° , or one-third of the cycle.

It is, therefore, apparent that for a definite value of E_{max} , the time that the valve is open is reduced by increasing the number of cells being charged. The degree of rectification is also reduced. By comparing the oscillogram in Figure 8 for full wave rectifica-

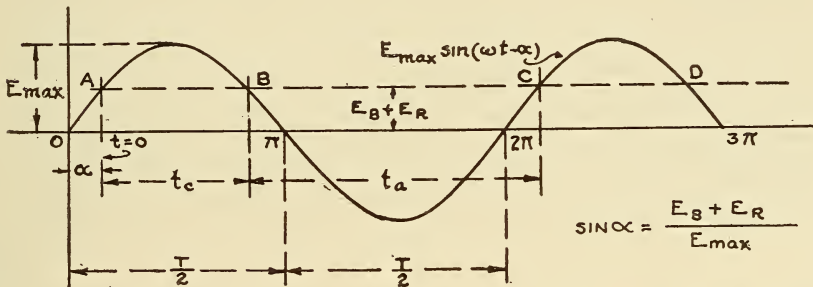

FIG. 20.—Relation between impressed voltage $E_{max} \sin (\omega t-\alpha)$ battery voltage E_B and counter emf E_R of rectifier

t_c and t_a are intervals when rectifying metal is cathode and anode, respectively,
 α = phase angle of voltage when valve opens ($t=0$)

tion with no battery and the oscillogram in Figure 21 for the same rectifier in series with a 48-volt battery, the effect of the battery in reducing the time that the valve is open is apparent. It is still more apparent when a transformer is used to reduce the voltage still further.

VI. ELECTROLYTIC RECTIFIER IN SERIES WITH INDUCTANCE

If the rectifying electrode has such a small area that the capacity effect may be neglected, it may be considered as a pure resistance which is low when the electrode is cathode, but very high when it is anode. If the impressed voltage is not too high, there will be no appreciable leakage current and the valve effect may be considered complete as in Figure 3. The operation of the valve then consists in allowing the current to flow only while it is open. If, however, there is considerable inductance in the circuit, the

current can flow for a longer interval of time than that for which the valve is open for the following reasons:

When the electrolytic valve opens, the current and voltage relations are essentially the same as they are immediately after closing

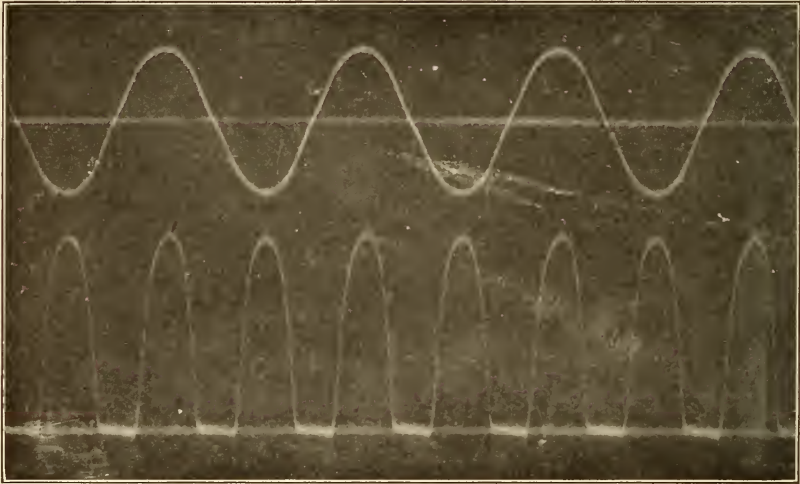

FIG. 21.—Full-wave rectification with four rectifiers as in Figure 5, charging a 24-volt battery

Upper curve represents impressed voltage and lower curve, rectified current

an ordinary electric circuit containing inductance, which means that the current is largely a temporary or transient quantity. The operation of a rectifier is similar to the opening and closing of the switch in synchronism with the voltage to be rectified and the

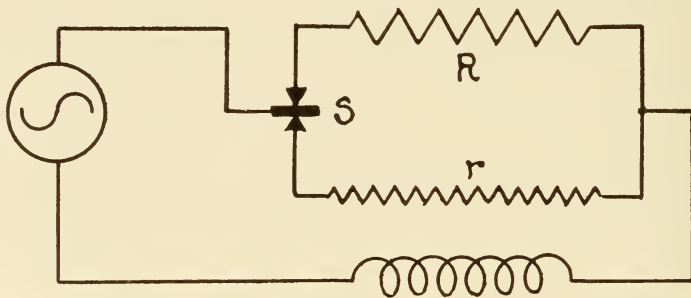

FIG. 22.—Operation of a rectifier, having no capacity, in series with inductance

rectified current consists of a succession of transient impulses. If the circuit contains only resistance, no transient quantities can appear. We may consider the rectifier as a switch, S , operating in synchronism with the impressed voltage (fig. 22), where r is a

very high resistance and R is a low resistance. When the switch is closed through R the voltage relations are represented by the following well-known equation:

$$E_{\max} \sin (\omega t - \alpha) = L \frac{dI}{dt} + IR$$

where

L = total inductance of the circuit,

R = total resistance of the circuit,

α = phase angle of the impressed emf when the switch is closed.

The solution of this equation gives

$$I = \frac{E_{\max}}{z} \left[\sin (\omega t - \alpha - \phi) + ce^{-\frac{R}{L}t} \right]$$

where

ϕ = phase angle between current and voltage,

z = impedance of the circuit,

c = constant.

To determine the value of c , let $I = 0$, when $t = 0$; that is, when the switch closes. Then:

$$c = \sin (\alpha + \phi)$$

$$\therefore I = I_{\max} \sin (\omega t - \alpha - \phi) + I_{\max} \sin (\alpha + \phi) e^{-\frac{R}{L}t} \quad (4)$$

where $I_{\max} \sin (\omega t - \alpha - \phi)$ is the permanent term and $I_{\max} \sin (\alpha + \phi) e^{-\frac{R}{L}t}$ is the transient term whose magnitude increases with the amount of inductance in the circuit. It is a maximum when $\sin (\alpha + \phi) = 1$; that is, when $(\alpha + \phi) = 90^\circ$, which is the case when $R = 0$ and $\alpha = 0$ (that is, when no counter emf is present). Then

$$e^{-\frac{R}{L}t} = 1 \text{ and } I_{\max} \sin (\omega t - \alpha - \phi) = I_{\max} \sin (\omega t - 90^\circ)$$

$$\therefore I = I_{\max} [1 - \cos \omega t] = -I_{\max} \cos \omega t \quad (5)$$

The current relations immediately after the switch is closed are shown in Figure 23,¹³ where the closure occurred when the permanent term $E_{\max} \sin (\omega t - \alpha - \phi)$ was a maximum. The permanent term is represented by the dotted sine curve, and the heavy logarithmic line represents the transient term. The actual current I is the algebraic sum of the two terms.

In the case of the rectifier valve when the impedance is wholly inductance and there is no counter emf the wave form of the

¹³ Arnold "Wechselstromtechnik," p. 652; 1910.

rectified current consists of a succession of pulsations similar to the curve in Figure 24, which represents equation $I = I_{\max} (1 - \cos \omega t)$. This is equivalent to the superposition of a DC com-

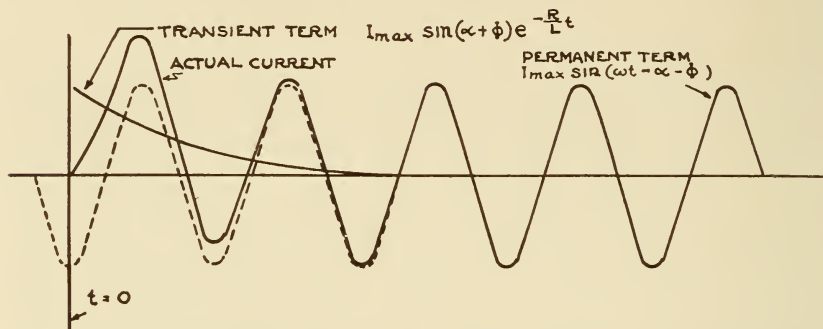

FIG. 23.—Current immediately after closing the switch in a circuit having a high inductance. In this case, the switch is closed (rectifier opens) at the time when the permanent component is a maximum

ponent equal to I_{\max} upon an AC component $I_{\max} \cos \omega t$.¹⁴ In this case the ratio (writing $\theta = \omega t$)

$$\frac{\text{DC}}{\text{AC}} = \frac{\int_0^{2\pi} \frac{I_{\max} (1 - \cos \theta) d\theta}{2\pi}}{\sqrt{\int_0^{2\pi} \frac{I_{\max}^2 (1 - \cos \theta)^2 d\theta}{2\pi}}} = \sqrt{\frac{2}{3}} = 0.816 \quad (6)$$

This value of 0.816 and the curve in Figure 24 can not be attained experimentally, since some resistance is always present.

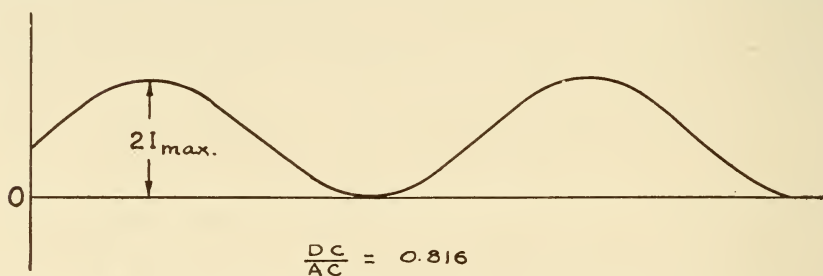

FIG. 24.—Maximum half-wave rectification with inductance, where the zero line is so displaced that the rectified current has a maximum value of $2 I_{\max}$

The maximum degree of rectification obtainable will vary from 0.636 to 0.816 with the phase angle ϕ between voltage and current as determined by the relative amount of resistance and inductance in the circuit. The results obtained by Zenneck¹⁵ are shown in Figures 25 and 26 for different areas of electrode sur-

¹⁴ Papalexii. Ann. der Phys., 39, p. 980; 1912.

¹⁵ Loc. cit.

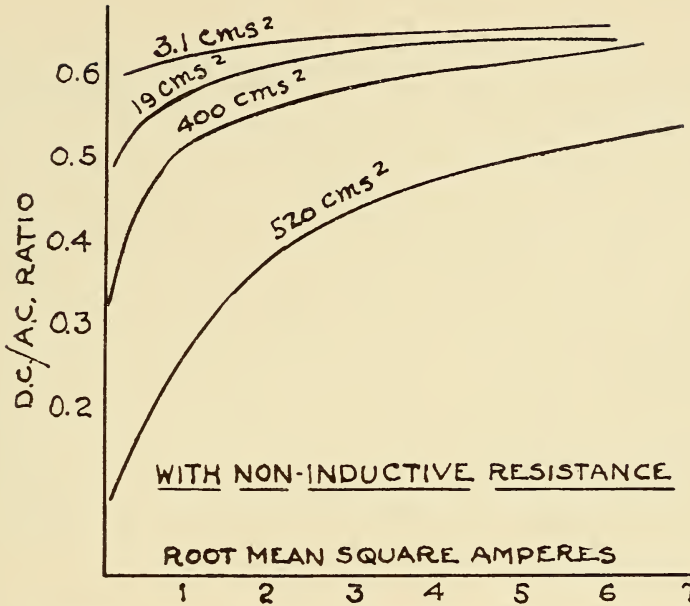

FIG. 25.—Zenneck's curves showing the relation between current and degree of rectification with an aluminum rectifier without inductance in series with different areas of electrode surface

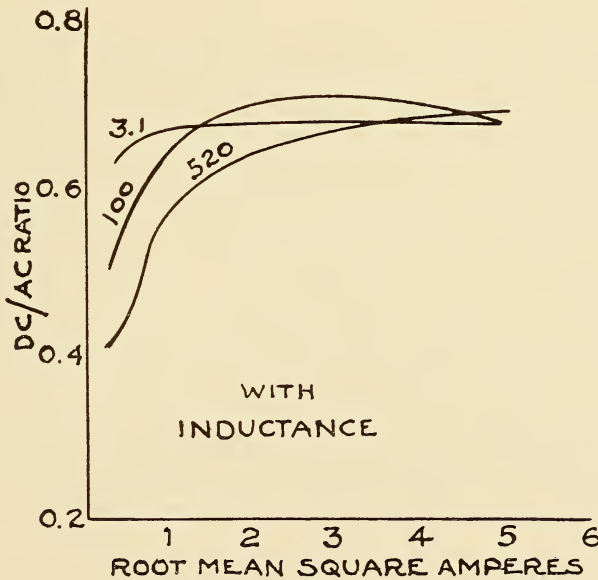

FIG. 26.—Zenneck's curves showing relation between current and degree of rectification of aluminum rectifier with inductance

The figures on the curves refer to the area of electrode in square centimeters

face without and with inductance, respectively, under otherwise the same conditions. The effect of high inductance in increasing the degree of rectification is more apparent in the case of the larger area of electrode, because the resistance of the larger electrode is less. Thus, for an area of 520 cm², with a current of 2 amperes, the increase in inductance almost doubles the degree of rectification.

An electrolytic rectifier having appreciable capacity and operating in series with an inductance may be represented by the diagram in Figure 27, where a synchronous switch alternately opens and closes the circuit through two different paths. One of these paths, a high resistance r , in parallel with a condenser

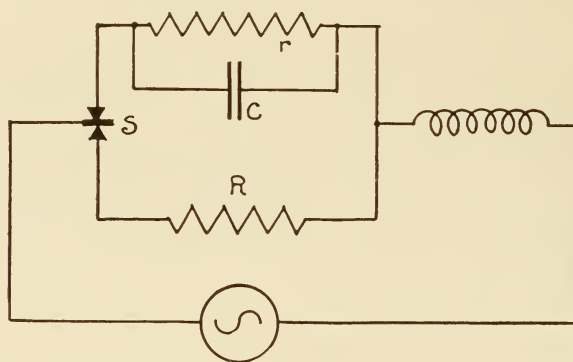

FIG. 27.—Operation of a rectifier, having capacity, in series with inductance

C represents the electrolytic valve when it is closed, and the other path a low resistance R , represents the valve when it is open. The mathematical equations for such a circuit are complicated.¹⁶

The effect of inductance upon the rectified current of an electrolytic rectifier having appreciable capacity is shown by comparing the oscillograms in Figures 28 and 29 with Figure 12 for a rectifier in series with a 24-volt battery.

Figure 12 represents a rectifier with no inductance. Figure 28 in series with an inductance of 250 millihenries and Figure 29 in series with 500 millihenries.

It is apparent from these oscillograms that the addition of inductance not only balances the capacity effect but increases the amplitude of the rectified wave. This is indicated in Figure 30 where curves *I* and *II* represent the increments in the transient component produced by the added inductance.

¹⁶ Steinmetz, *Transient Electric Phenomena and Oscillations* (1909), p. 88, et seq.

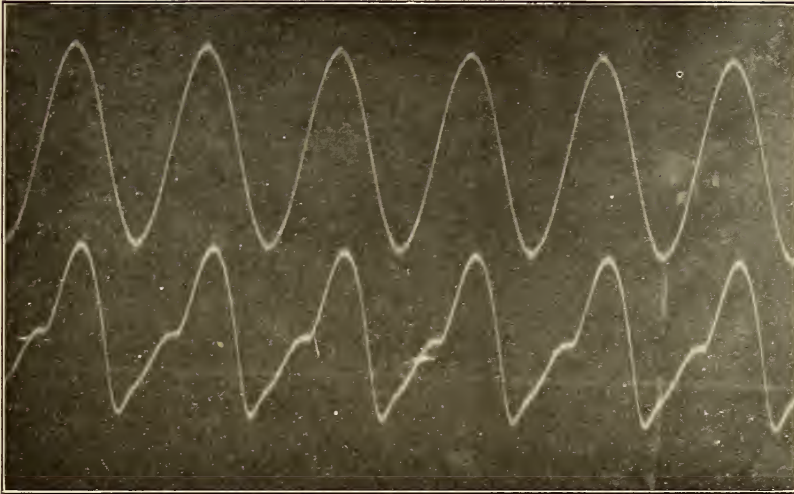

FIG. 28.—Rectified current of an aluminum rectifier with an inductance of 250 mh in series

Upper curve represents impressed voltage and lower curve rectified current

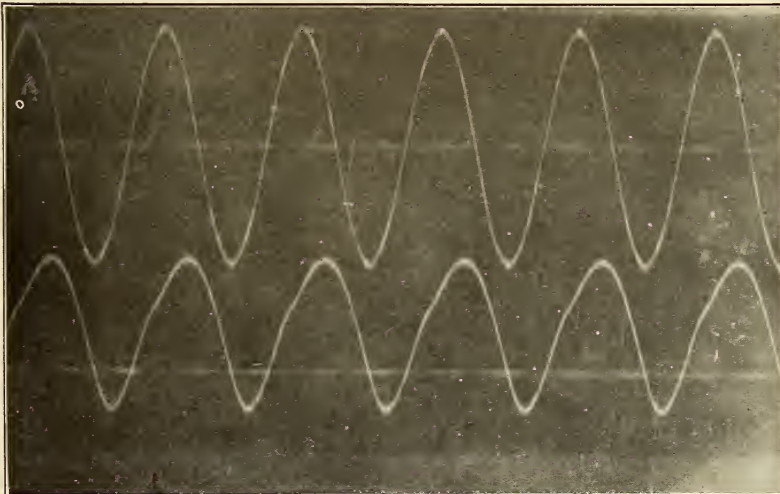

FIG. 29.—Rectified current of aluminum rectifier with an inductance of 500 mh in series

Upper curve represents impressed voltage and lower curve rectified current

In the case of full-wave rectification in a circuit, the impedance of which is entirely inductance, the rectified current consists of two superimposed components, each of which is a $(1 - \cos \theta)$ curve, one-half cycle apart as in Figure 31. Their sum is a direct current,

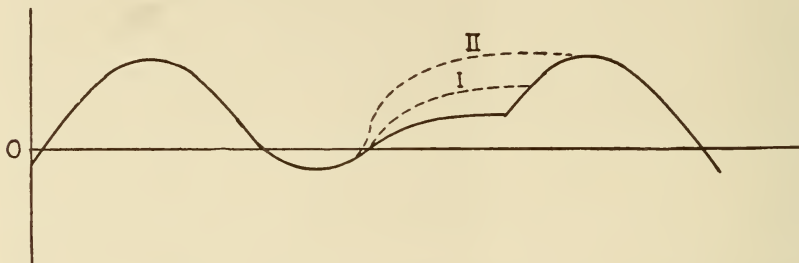

FIG. 30.—The portion of the rectified wave built up by successive additions of inductance in series with the rectifier

whose average value and root mean square value are both equal to $2 I_{\max}$. The ratio of DC/AC in Figure 31 is therefore 1, which is the theoretical maximum value obtainable by full-wave rectification. This value was practically attained with the three-electrode tantalum rectifier indicated in Figure 32 with which the

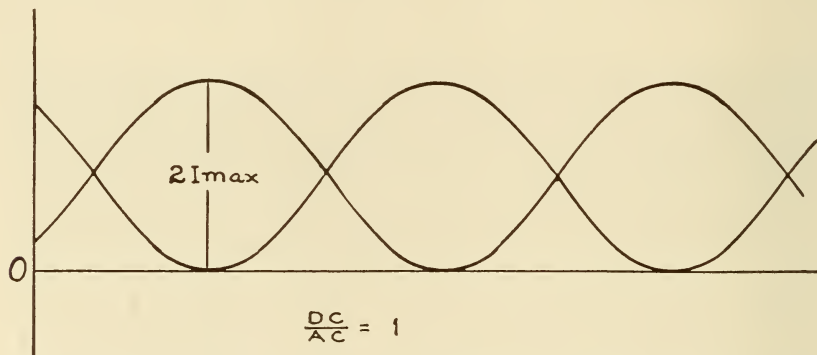

FIG. 31.—Superimposed rectified currents obtained with three-electrode rectifier and inductances as in Figure 32

value obtained for the DC/AC ratio was 1.03. The oscillogram shown in Figure 33 represents the rectified current of this rectifier and its DC/AC ratio was 0.98. The ripple is due to the fact that the components do not have an exact sine form, but have the form of the oscillogram shown in Figure 29. The superposition of two such waves 180° apart produces a ripple like that obtained for the full-wave rectification shown in Figure 33.

VII. ELECTROLYTIC RECTIFIER IN SERIES WITH AN IRON CORE INDUCTANCE

The effect of inductance upon the shape of the rectified wave has been shown. In the absence of iron the magnetic flux is proportional to the current, and the same curve in Figure 24 may also represent the magnetic flux. In this case the equation for the curve would be

$$\phi = \phi_{\max}(1 - \cos \theta) \quad (7)$$

In the presence of iron, however, the inductance of the circuit varies with the magnetization of the iron throughout each cycle. In other words, the current varies with the flux according to the relation existing in the hysteresis curve for the magnetization of the particular sample of iron. This relation is shown in Figure 34¹⁷ when the valve is opened at $t=0$. When the hysteresis loss is large the rectified wave is more peaked (fig. 35) and the degree of rectification is slightly reduced. When the hysteresis loss is small the rectified wave is broader and the degree of rectification is slightly increased (fig. 36). In the case of Figure 35 the inductance used was a coil consisting of a relatively few turns and a large iron core. The hysteresis of this coil was large. In the case of Figure 36 the inductance had many turns and a small iron core and, therefore, a small hysteresis loss. It is, therefore, apparent that a coil similar to the latter should be used to obtain the highest degree of rectification.

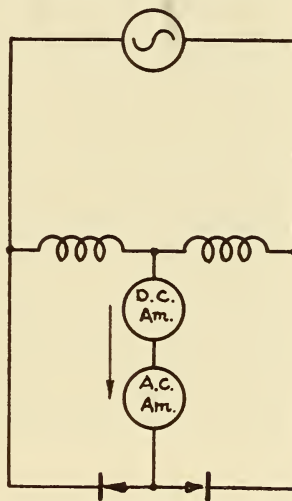

FIG. 32.—Diagram of three-electrode rectifier with inductance.

Direction of rectified current indicated

VIII. PERFORMANCE TESTS OF AN ALUMINUM RECTIFIER

Since the aluminum rectifier can be operated at fairly high voltage it is ordinarily used in series with a lamp on the house-lighting circuit, but, as pointed out in the previous discussion, its performance depends upon the electrical characteristics of the circuit. In order to determine the kind of performance which may be expected under different conditions, the following tests were made. The test circuit (fig. 37) was so arranged that the

¹⁷ Arnold, loc. cit.

wattage input, the impressed voltage, the average current, the root mean square current, and battery voltage could be observed directly. The wave form of the impressed voltage and rectified current was also observed with an oscillograph and photographed when desired.

Several aluminum rectifiers on the market were tested and the results in the following tables and curves were obtained on one of them. This rectifier had an aluminum area of about 23 cm² and a volume of electrolyte of about 350 cm³. It was designed for B-battery charging and gave 360 hours of continuous service

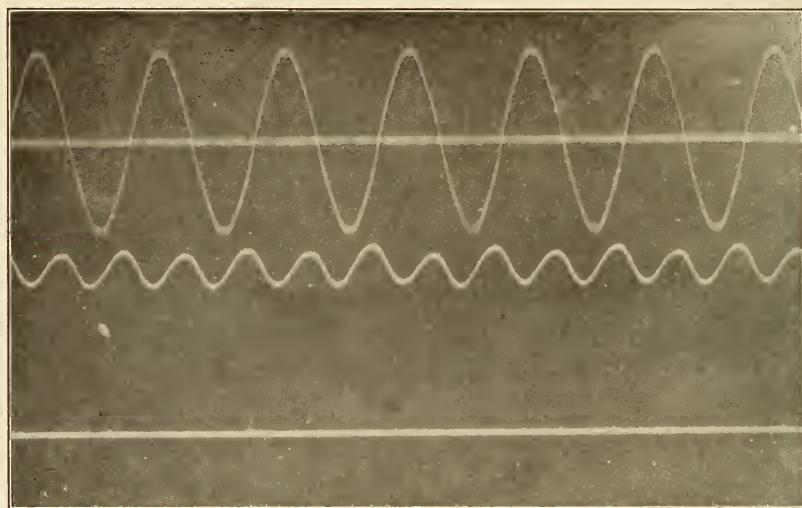

FIG. 33.—Rectified current obtained with a three-electrode tantalum rectifier in a highly inductive circuit indicated in Figure 32

The upper curve represents impressed voltage; the lower curve, rectified current. The lower straight line represents zero current

at the rate of 0.25 ampere. The average temperature on continuous operation of this rectifier was about 40° C.

The currents chosen for test were those which correspond approximately to the use of a 40, 60, and 100 watt lamp on the lighting circuit. The number of lead cells charged were varied from zero to 24 in multiples of six. A frequency of 60 cycles was used except as noted. The effect of frequency on the DC/AC ratio was determined by observation at 30, 60, and 180 cycles. The degree of rectification was 0.60, 0.56, and 0.50, respectively.

Under all conditions of operation the degree of rectification as measured by the DC/AC ratio decreased as the number of cells being charged was increased, as would be expected. At the same time the watt efficiency was increased because the IR drop in

voltage was proportionately reduced as the battery voltage approached the line voltage.

Table 1 includes the results obtained with lamp resistance in series with the rectifier and battery. To determine the effect of temperature the same series of measurements was made at 50° C. under otherwise identical conditions. Comparison of the results obtained at 50° C. with those obtained at room temperature showed that the electrical performance of this rectifier was not appreciably affected by such change in temperature. This does not mean, of course, that the rate of deterioration of electrodes and electrolyte and, therefore, the life of the rectifier was not affected.

In the case of one aluminum rectifier in which the aluminum area and volume of electrolyte were too small for its current rating its temperature rose to 80° C. after two hours of continuous operation and the DC/AC ratio became practically zero. On cooling again to room temperature the rectifier regained its rectifying power, but would not continue to operate without overheating and consequent loss of rectification. Its loss of rectifying power at the higher temperature is made apparent by comparing the oscillogram in Figure 38 for this rectifier at room temperature with that in Figure 39 for the same one at 80° C.

As previously shown in Figure 5 four rectifiers may be so connected that full wave rectification is obtained. Comparison of the average DC/AC ratios shows that 50 per cent greater rectification may be obtained with four rectifiers than with one. The increase in energy efficiency, however, is almost negligible and does not justify the use of this scheme on the basis of increased efficiency.

As shown in the theoretical discussion, the rectification ratio DC/AC may be increased by the addition of inductance to the circuit. This was the case when an inductance without iron was

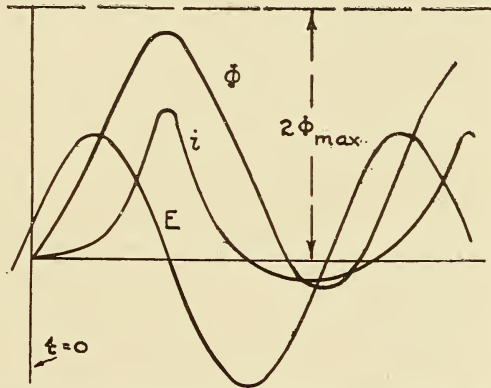

FIG. 34.—Diagram showing relation between the flux and current immediately after closing a switch, when the inductance contains iron.

The switch closes (or rectifier opens) at $t=0$.

used as is shown by the oscillogram in Figure 29, for a rectifier in series with an inductance of 500 millihenries. The transient component was so large that the rectified wave occupied almost the entire cycle. The effect of inductance, however, also depends upon the presence of iron and the consequent hysteresis loss. For the purpose of demonstrating the effect of iron two coils were used; one consisted of many turns of small resistance wire and a small iron core designated as reactance *A*; and the other consisted

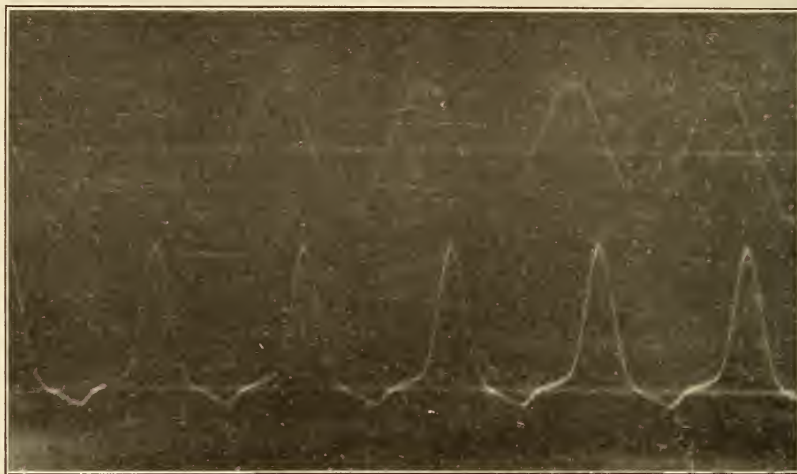

FIG. 35.—Rectified current of an aluminum rectifier in series with reactance coil having high hysteresis loss

Upper curve represents impressed voltage

of a few turns of large resistance wire and a large iron core designated as reactance *B*. Their characteristics were as follows:

| | A | B |
|----------------------------|------|------|
| Resistance.....ohms.. | 118 | 4.3 |
| Inductance.....henries.. | 1.05 | 2.45 |
| Total impedance.....ohms.. | 413 | 924 |

The hysteresis effect was, therefore, greater in the case of coil *B* than in the case of coil *A*. The wave distortion due to hysteresis is clearly shown in the "peaked" waves of the oscillogram in Figure 35, while the oscillogram in Figure 36 shows the wave form obtained with coil *A*. The latter is practically the same as that obtained with the inductance without iron (fig. 29).

Comparison of the results in Table 2 shows that the energy efficiency obtained with coil *B* is much greater than with coil *A*.

This is due to the smaller I^2R loss in coil *B* as compared with coil *A*. The power factor is also much less because of the higher

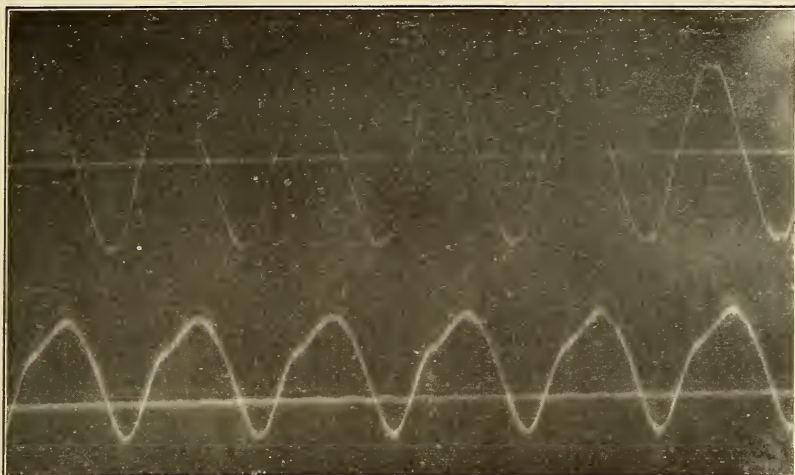

FIG. 36.—Rectified current of an aluminum rectifier in series with reactance coil having little hysteresis loss

inductance of coil *B*. The ratio of *DC/AC* averages about 0.61, or 20 per cent, higher with coil *A* than with lamp resistance (0.50) or with coil *B*.

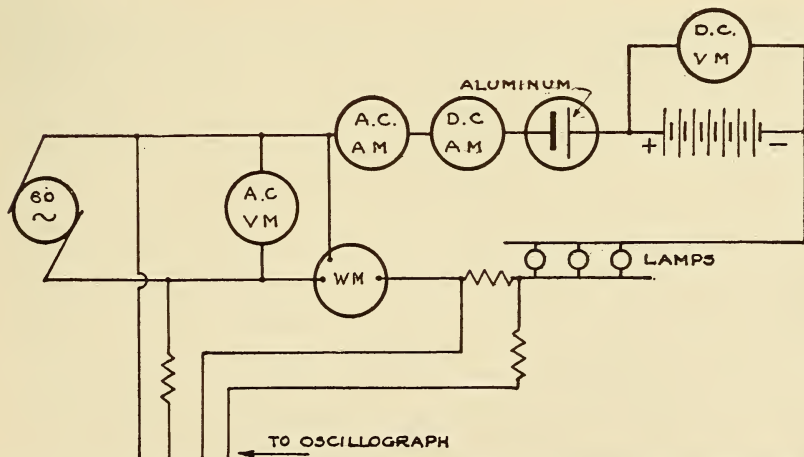

FIG. 37.—Circuit used for testing aluminum rectifier and obtaining data summarized in Tables I, 2, and 3

In Table 2, the variation of current in coil *A* was obtained by using one coil, two in series, or two in parallel. Variation of current in coil *B* was obtained by varying the impressed voltage. It will be noted that a much greater current is obtained (0.62

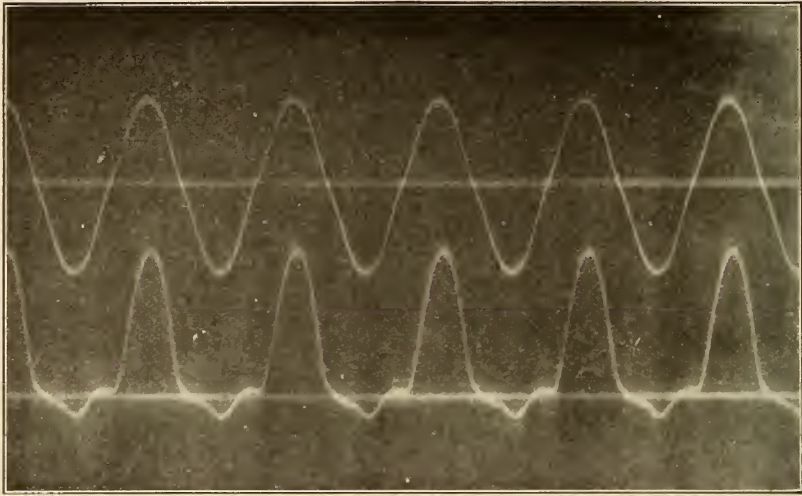

FIG. 38.—Rectified current of an aluminum rectifier which was later found to be over rated. (Compare with fig. 39)

Upper curve represents impressed voltage

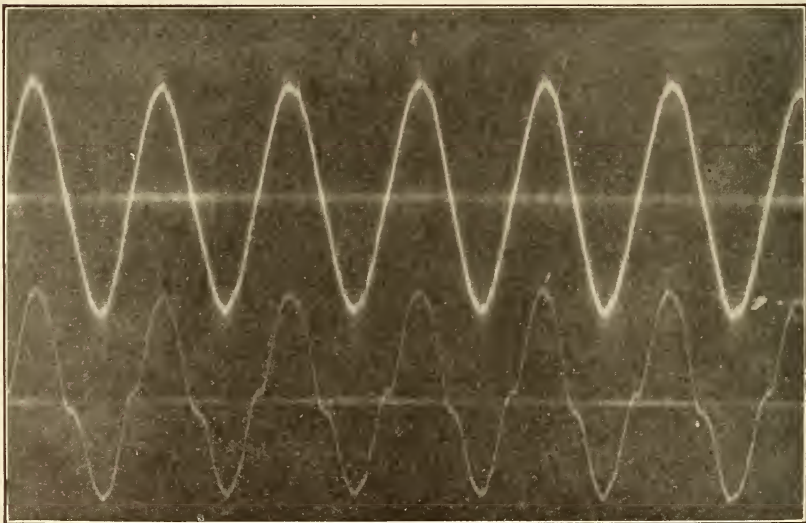

FIG. 39.—Rectified current of the same rectifier shown in Figure 38 at 80° C.

Upper curve represents impressed voltage and lower curve rectified current. Leakage current is excessive and due to high temperature

ampere) with 111 volts than might be expected, its impedance being 924 ohms. It must be remembered, however, that a DC component of considerable magnitude is present to which the reactance coil offers a resistance of only 4.3 ohms.

A series of tests was made to determine the performance which may be expected of an aluminum rectifier used directly upon the line voltage without any series resistance or reactance. For this purpose a variable step-down transformer was used and

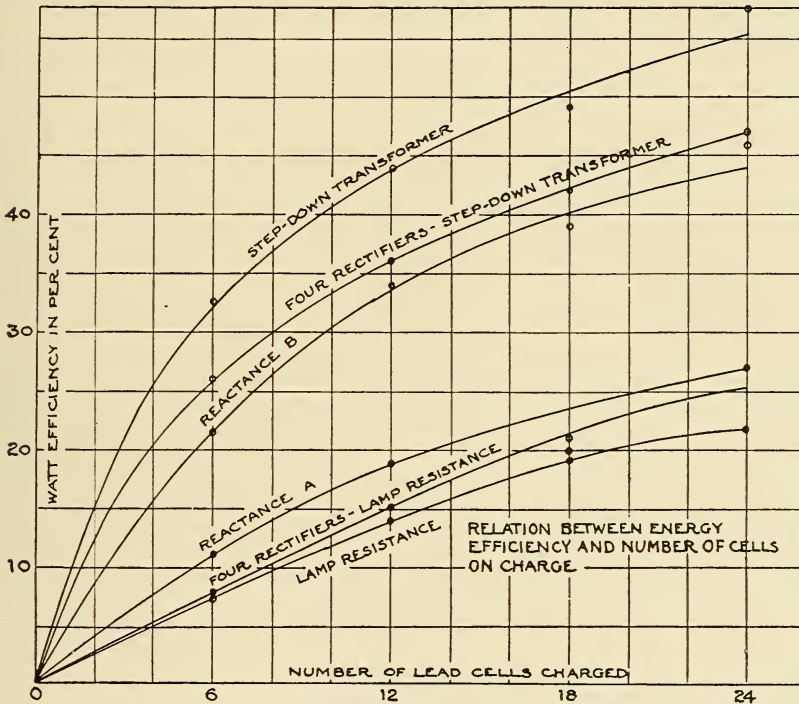

FIG. 40

sufficient voltage applied in each case to obtain practically the same currents as obtained with the 40, 60, and 100 watt lamps on the house-lighting circuit. The results are shown in Table 3.

It was found that the rectification on a step-down transformer was no better than it was with lamp resistance, while the efficiency was somewhat greater, not including the transformer loss. The use of four rectifiers on the step-down transformer gave a high degree of rectification (0.67), but the energy efficiency was slightly less than with a single rectifier. The results of tests on the aluminum rectifier are summarized in the curves in Figure 40.

TABLE 1.—Aluminum Rectifier with Lamp Resistance

| AC | AC | Input | Power factor | Resistance | Cells | DC | DC/AC ratio | Energy efficiency |
|--------------------------------------|---------|-------|--------------|-----------------------|-------|---------|-------------|-------------------|
| Volts | Amperes | Watts | Per cent | | | Amperes | | Per cent |
| 120 | 0.22 | 19 | 72 | 40-w. lamp | 0 | 0.12 | 0.54 | 0 |
| 120 | .19 | 17 | 75 | 40-w. lamp | 12 | .096 | .51 | 14 |
| 121 | .17 | 16 | 77 | 40-w. lamp | 24 | .073 | .43 | 22 |
| 120 | .42 | 35 | 69 | 60-w. lamp | 0 | .24 | .57 | 0 |
| 120 | .37 | 32 | 71 | 60-w. lamp | 12 | .20 | .54 | 15 |
| 121 | .33 | 30 | 76 | 60-w. lamp | 24 | .15 | .44 | 23 |
| 122 | .70 | 67 | 79 | 100-w. lamp | 0 | .38 | .55 | 0 |
| 121 | .62 | 57 | 77 | 100-w. lamp | 12 | .32 | .51 | 14 |
| 121 | .52 | 49 | 79 | 100-w. lamp | 24 | .24 | .45 | 22 |
| FOUR RECTIFIERS WITH LAMP RESISTANCE | | | | | | | | |
| 121 | 0.26 | 31 | 100 | 40-w. lamp | 0 | 0.21 | 0.81 | 0 |
| 121 | .22 | 26 | 99 | 40-w. lamp | 12 | .16 | .70 | 14 |
| 120 | .18 | 21 | 98 | 40-w. lamp | 24 | .12 | .64 | 25 |
| 121 | .51 | 63 | 100 | 60-w. lamp | 0 | .42 | .82 | 0 |
| 121 | .42 | 52 | 100 | 60-w. lamp | 12 | .32 | .75 | 15 |
| 121 | .34 | 41 | 98 | 60-w. lamp | 24 | .24 | .70 | 27 |
| 121 | .81 | 101 | 100 | 100-w. lamp | 0 | .68 | .84 | 0 |
| 121 | .67 | 84 | 96 | 100-w. lamp | 12 | .52 | .78 | 15 |
| 121 | .55 | 67 | 100 | 100-w. lamp | 24 | .40 | .73 | 28 |

TABLE 2.—Aluminum Rectifier in Series With Reactance

| REACTANCE COIL "A" OF MANY TURNS AND SMALL IRON CORE | | | | | | | | |
|--|---------|-------|--------------|-------|---------|-------------|-------------------|--|
| AC | AC | Input | Power factor | Cells | DC | DC/AC ratio | Energy efficiency | |
| Volts | Amperes | Watts | Per cent | | Amperes | | Per cent | |
| 120 | 0.18 | 13 | 60 | 0 | 0.12 | 0.67 | 0 | |
| 119 | .17 | 13 | 66 | 12 | .098 | .58 | 18 | |
| 119 | .14 | 13 | 78 | 24 | .067 | .48 | 24 | |
| 121 | .31 | 21 | 57 | 0 | .22 | .71 | 0 | |
| 120 | .25 | 20 | 68 | 12 | .16 | .63 | 18 | |
| 120 | .21 | 20 | 79 | 24 | .11 | .51 | 26 | |
| 120 | .56 | 33 | 49 | 0 | .40 | .71 | 0 | |
| 120 | .41 | 30 | 75 | 12 | .26 | .63 | 21 | |
| 121 | .32 | 27 | 70 | 24 | .17 | .55 | 30 | |
| REACTANCE COIL "B" OF FEW TURNS AND LARGE IRON CORE | | | | | | | | |
| 78 | 0.20 | 3.0 | 19 | 0 | 0.10 | 0.50 | 0 | |
| 91 | .17 | 6.8 | 43 | 12 | .083 | .48 | 30 | |
| 91 | .20 | 10 | 56 | 24 | .091 | .46 | 42 | |
| 99 | .37 | 7.0 | 16 | 0 | .20 | .54 | 0 | |
| 109 | .38 | 14 | 34 | 12 | .19 | .50 | 33 | |
| 108 | .41 | 21 | 44 | 24 | .20 | .49 | 46 | |
| 106 | .58 | 9.0 | 13 | 0 | .30 | .52 | 0 | |
| 114 | .60 | 20 | 29 | 12 | .30 | .51 | 38 | |
| 111 | .62 | 30 | 44 | 24 | .31 | .50 | 50 | |

TABLE 3.—Aluminum Rectifier on Step-Down Transformer

| AC | AC | Input | Power factor | Cells | DC | DC/AC ratio | Energy efficiency |
|-------|---------|-------|--------------|-------|---------|-------------|-------------------|
| Volts | Amperes | Watts | Per cent | | Amperes | | Per cent |
| 10 | 0.22 | 1.7 | 77 | 0 | 0.11 | 0.50 | 0 |
| 36 | .18 | 4.7 | 73 | 12 | .086 | .46 | 44 |
| 55 | .18 | 6.2 | 63 | 24 | .075 | .41 | 57 |
| 18 | .40 | 5.0 | 70 | 0 | .22 | .55 | 0 |
| 44 | .37 | 10 | 61 | 12 | .18 | .48 | 41 |
| 60 | .31 | 12 | 65 | 24 | .14 | .46 | 55 |
| 10 | .70 | 6.1 | 87 | 0 | .39 | .56 | 0 |
| 38 | .60 | 15 | 66 | 12 | .29 | .48 | 27 |
| 57 | .52 | 19 | 64 | 24 | .24 | .45 | 59 |

| FOUR RECTIFIERS ON STEP-DOWN TRANSFORMER | | | | | | | |
|--|------|-----|-----|----|------|------|----|
| 20 | 0.26 | 4.7 | 90 | 0 | 0.18 | 0.69 | 0 |
| 44 | .23 | 8.6 | 87 | 12 | .14 | .59 | 38 |
| 62 | .19 | 10 | 87 | 24 | .11 | .56 | 50 |
| 24 | .50 | 12 | 100 | 0 | .37 | .74 | 0 |
| 50 | .42 | 20 | 93 | 12 | .28 | .67 | 34 |
| 68 | .36 | 22 | 90 | 24 | .22 | .61 | 43 |
| 22 | .73 | 16 | 100 | 0 | .54 | .74 | 0 |
| 47 | .70 | 30 | 91 | 12 | .45 | .64 | 36 |
| 68 | .46 | 34 | 91 | 24 | .35 | .76 | 48 |

IX. DESCRIPTION OF THE TANTALUM RECTIFIER

The rectifying property of tantalum has been studied by Schulze and others. Schulze¹⁸ found that a solution of potassium carbonate gave better results than other solutions which he tried. Recently the use of sulphuric acid as an electrolyte in the tantalum rectifier has proven successful, and such a rectifier is now on the market. The electrical resistivity of sulphuric acid is low, and the I^2R loss is consequently less than it is with the poorly conducting electrolytes used in the aluminum rectifier. Furthermore, the resistance of tantalum to the corrosive action of the electrolyte gives the rectifier a longer life than that of the aluminum. The tantalum rectifier as now on the market consists of a strip of tantalum, a lead or lead-peroxide electrode, and an electrolyte of sulphuric acid of about the same specific gravity as is used in storage batteries. A transformer is combined with the rectifier to reduce the line voltage to the proper operating voltage (fig. 41) and sufficient cooling surface is provided to prevent an excessive rise in temperature.

The rectifying property of tantalum is acquired almost immediately upon the application of an alternating electromotive force to a fresh strip of the metal due to the rapid formation of a film of oxide upon its surface. The wave form of the rectified current

¹⁸ Ann. d. Physik, 23, p. 226; 1907.

obtained with the tantalum rectifier was similar to that of the aluminum rectifier.

As previously pointed out, the capacity and, therefore, the capacity current of an electrolytic rectifier increases with the area of the rectifying electrode. At low current densities the capacity

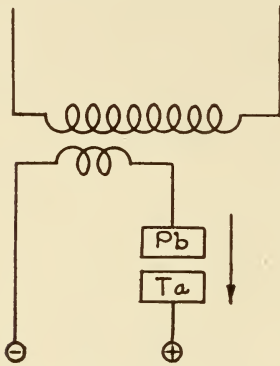

FIG. 41.—Diagram of tantalum rectifier including transformer.

Direction of rectified current is indicated

current is a considerable proportion of the total current, so that the degree of rectification as measured by the DC/AC ratio is less at the lower-current densities. The relation between the total current through the rectifier and the DC/AC ratio is shown in Figure 42 for three tantalum electrodes of different areas. One of these had an area of 106 cm^2 , one had an area of 22 cm^2 , and a third was a commercial rectifier with a tantalum surface of about 15 cm^2 .

At high-current densities the rectification ratio is considerably better and approximates the theoretical maximum value of 0.636. The curves in Figure 42 are similar to those obtained by Zenneck for aluminum to which previous reference was made.

The addition of inductance in series with the tantalum rectifier increased the DC/AC ratio, just as it should for reasons previously explained. The curves in Figure 43 show the relation between the

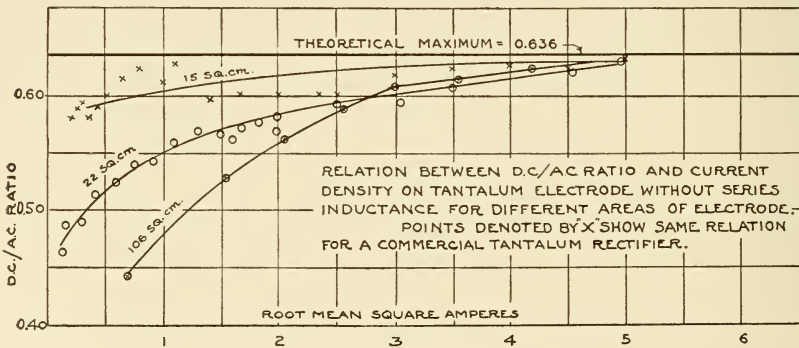

FIG 42

DC/AC ratio and the total current in root mean square amperes for half wave and also for full-wave rectification. For comparison, a third curve is given in Figure 43 representing half-wave rectification without inductance in series with the rectifier.

The curves in Figures 42 and 43 show that a certain minimum current (about one-tenth ampere with the areas used) is required

to obtain an appreciable degree of rectification. In order to obtain this minimum current a certain minimum voltage is necessary. This may be determined by gradually increasing the impressed alternating electromotive force and observing the corresponding current. In Figure 44, curves *A* and *B* represent the direct and

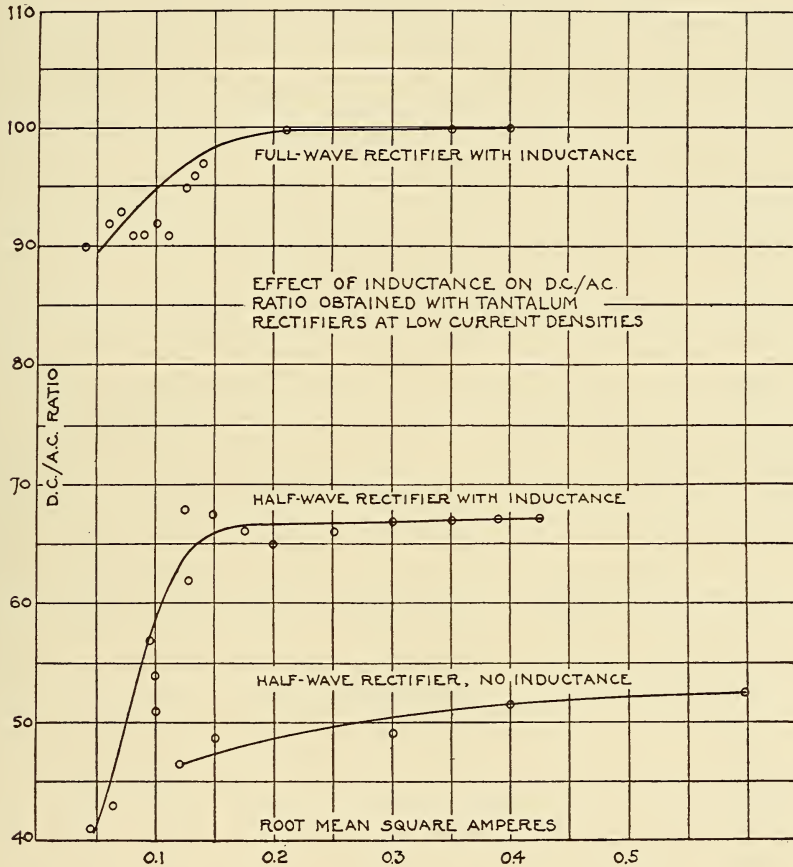

FIG. 43

alternating current, respectively, obtained by gradually increasing the voltage across the rectifier. In this case the minimum AC voltage obtained by extrapolation of the curve back to the voltage axis is about 14 volts. This is the minimum voltage of the lead acid tantalum cell. Curve *C* was obtained with a commercial tantalum rectifier for which the minimum voltage graphically determined was about 3.6 volts. The minimum voltage of the commercial rectifier was, therefore, much less than it was for the laboratory type composed of tantalum and lead electrodes in

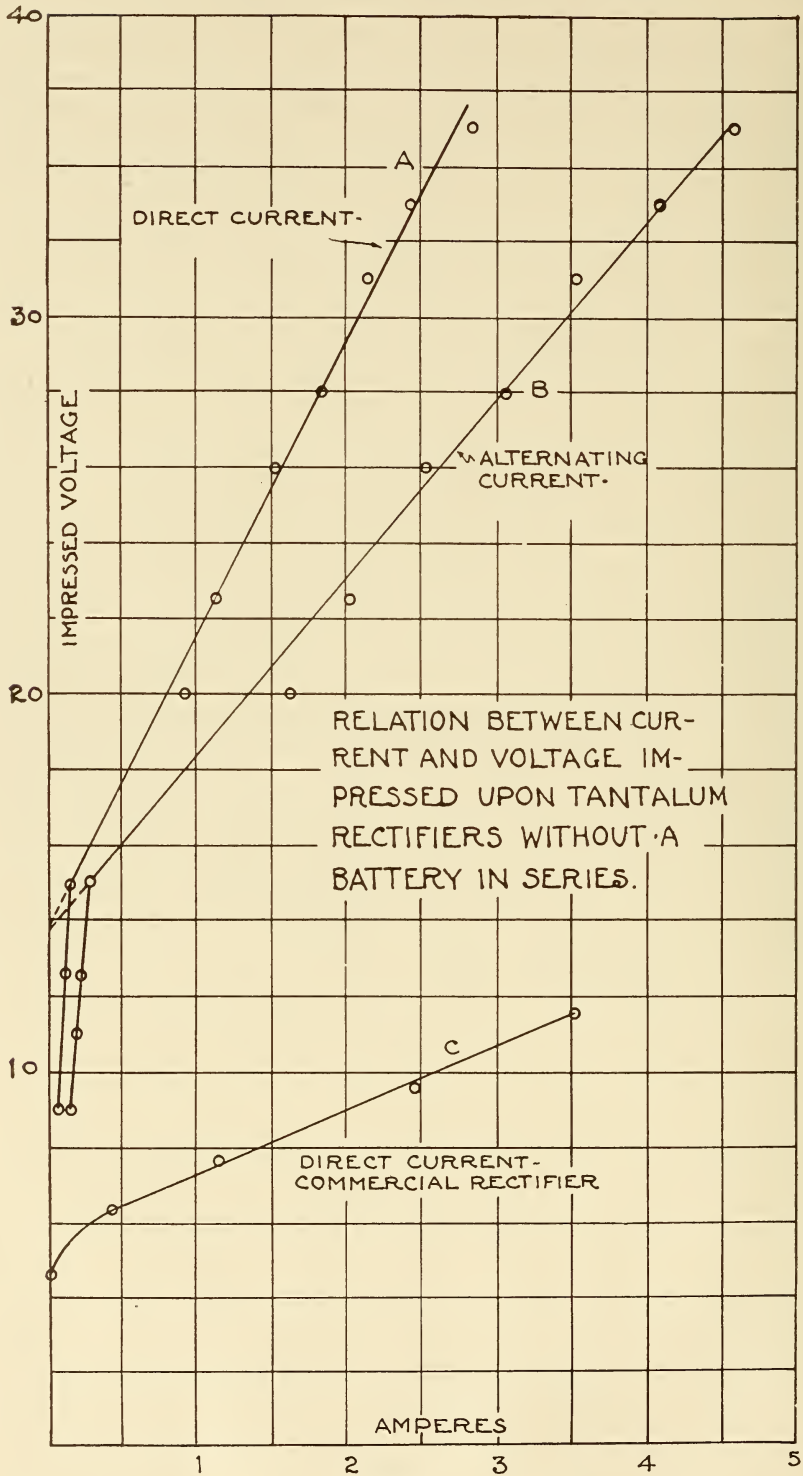

FIG. 44

sulphuric acid having a specific gravity of 1.250. This explains the higher current obtained with the commercial rectifier at a given voltage.

X. PERFORMANCE TESTS OF A TANTALUM RECTIFIER AND THEORETICAL DERIVATION OF RELATION BETWEEN OUTPUT AND BATTERY VOLTAGE

The performance of the commercial tantalum rectifier is represented by the curves in Figure 45. The output in amperes and in watts were observed and the energy efficiency was computed for different battery voltages. The maximum output in watts was obtained at a battery voltage of about 5 volts, while the maximum efficiency was obtained at 10.3 volts. The reason for the position of these maxima may be apparent from the following considerations: Let

E_{\max} = peak value of impressed voltage,

E_B = battery voltage,

R = total resistance,

I = average current delivered to battery.

Then average power delivered to battery is given by equation:

$$P = E_B \times I$$

$$P = \frac{E_B}{2\pi R} \int_0^\pi E_{\max} \sin \theta \cdot d\theta - E_B \cdot d\theta - \frac{E_B}{\pi R} \int_0^\alpha E_{\max} \sin \theta \cdot d\theta - E_B \cdot d\theta \quad (8)$$

Or

$$P = \frac{2E_{\max} E_B \cos \alpha + 2E_B^2 \alpha - E_B^2 \pi}{2\pi R}$$

$$\frac{dP}{dE_B} = \frac{E_{\max} \cos \alpha + 2E_B \alpha - E_B \pi}{\pi R} \text{ and } \frac{dP}{d\alpha} = -\frac{E_{\max} E_B \sin \alpha + 2E_B^2}{2\pi R}$$

when P is a maximum,

$$\frac{dP}{dE_B} = 0 \text{ and } \frac{dP}{d\alpha} = 0$$

Then

$$E_B = \frac{E_{\max} \cos \alpha}{\pi - 2\alpha} \quad (9)$$

This equation represents the relation between the peak voltage E_{\max} and the battery voltage E_B , when the power output is a

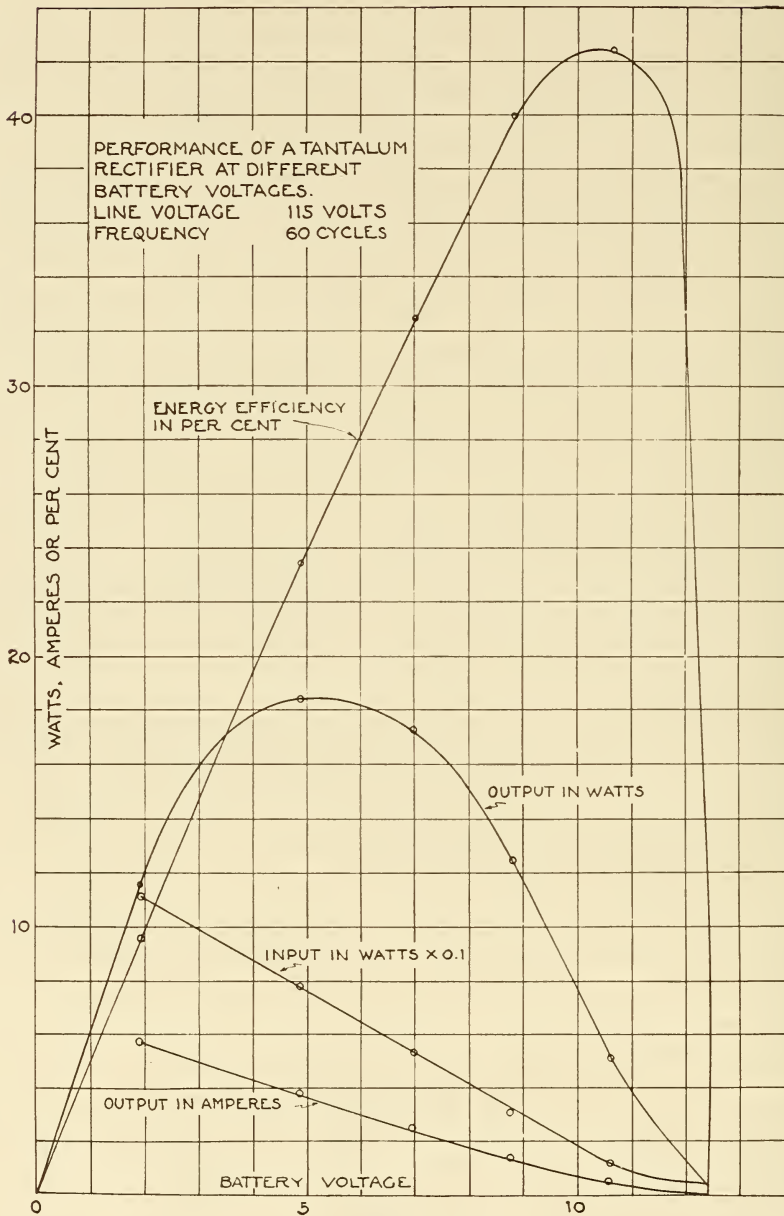

FIG. 45

maximum. Thus at the maximum power output in Figure 45, $E_B = 5$ volts. The peak voltage of the rectifier was 12.5 volts. Then

$$\sin \alpha = \frac{E_B}{E_{\max}} = \frac{5}{12.5} = 0.4$$

and

$$\alpha = \sin^{-1} 0.4 = 23.6^\circ \text{ and } \cos \alpha = 0.916$$

Substituting in equation (9), we have

$$E_B = \frac{12.5 \times 0.916}{\pi - (2 \times 23.6^\circ)} = 4.9$$

which agrees closely with the voltage at maximum output, namely, 5 volts.

The rating of this rectifier was made at 6 volts, or fairly near the voltage for maximum output. The transformer loss without a battery load was only 4 watts. Since the relation between input and battery voltage is approximately linear, and the energy efficiency is the ratio of input to output, the maximum efficiency is obtained at a battery voltage higher than that at which maximum output is obtained. This is apparent in Figure 45, where the maximum efficiency of about 42 per cent was obtained at a battery voltage of 11 volts.

XI. DESCRIPTION OF THE THERMIONIC RECTIFIER¹⁹

The thermionic rectifier utilizes the phenomenon of electronic emission from a hot tungsten filament. If such a filament be made to serve as one electrode in a highly evacuated tube along with a cold electrode having a positive potential with respect to the filament, electrons will flow from the hot filament to the cold electrode. If the cold electrode or "plate" be made negative with respect to the filament, the electrons emitted will be repelled by the negative plate and no current will flow. If an alternating potential be applied, electrons will flow only during the half cycle when the plate is positive. An alternating current is thereby rectified. Such a tube, having a high vacuum, is usually referred to as a "kenetron," and may be used to rectify currents up to 250 milliamperes and voltages up to 100,000 volts.

However, in the kenetron, a space charge or electrostatic field is set up around the hot cathode by the electrons themselves, and their flow to the anode is definitely limited. In order to

¹⁹ G. S. Meikle, G. E. Review 19, p. 297; 1916.

obtain a current of only a few milliamperes a voltage of 100 to 500 volts is required. Because of the necessity of using such a high voltage, the kenetron is not practicable for rectifying high currents at ordinary low voltages. By the introduction of an inert gas, particularly argon, positive ions are produced by the impacts of the gas molecules with the electrons. The space charge is neutralized by the positive ions to such an extent that the voltage necessary to maintain a given current is reduced to a few volts. The ordinary thermionic rectifier, therefore, is a modified kenetron containing argon at the proper pressure (3 to 8 cm, measured cold).

The arrangement for using the thermionic tube as a rectifier is indicated in Figure 46 where a transformer is necessary to reduce

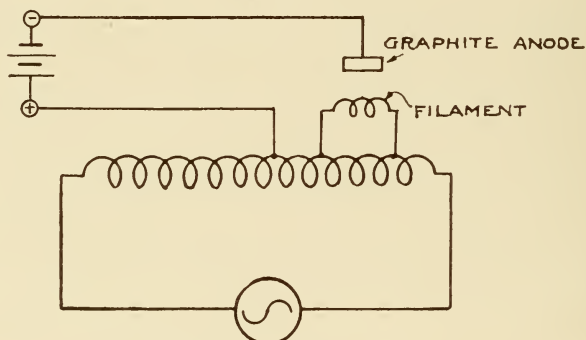

FIG. 46.—*Thermionic rectifier*

the line voltage to the proper value for heating the filament and also for the battery for which the rectifier is rated. This type of rectifier is self-starting. When the circuit is closed the hot filament emits electrons which ionize the argon gas and the arc between filament and plate forms immediately. The arc may be maintained by a voltage as low as 1 volt, but usually it requires from 4 to 8 volts, DC. After the arc is once started it may be maintained without further excitation of the filament, but this is not advisable because the arc concentrates on one portion of the filament and shortens its life and no greater efficiency is obtained. The usual life of the tube varies from several hundred to several thousand hours, depending upon the current used.

XII. PERFORMANCE TESTS OF THERMIONIC RECTIFIERS

Data showing the performance of thermionic rectifiers made by two different manufacturers are given in Tables 4 and 5. They were chosen from the sizes in common use. The results for one of them, rectifier *Q*, are represented by the curves in Figure 48.

The power input at different charging rates was measured with a wattmeter, and the output was taken as the product of the battery voltage and the charging current. The energy efficiency is the ratio of this computed output to the input. The energy efficiency of the thermionic rectifier is limited principally by the transformer loss, the heat required by the filament, and the voltage required to maintain the arc. No determination of these separate losses was made. The no-load loss of the rectifier P was 35 watts and that of rectifier Q was 40 watts, most of which is due to the

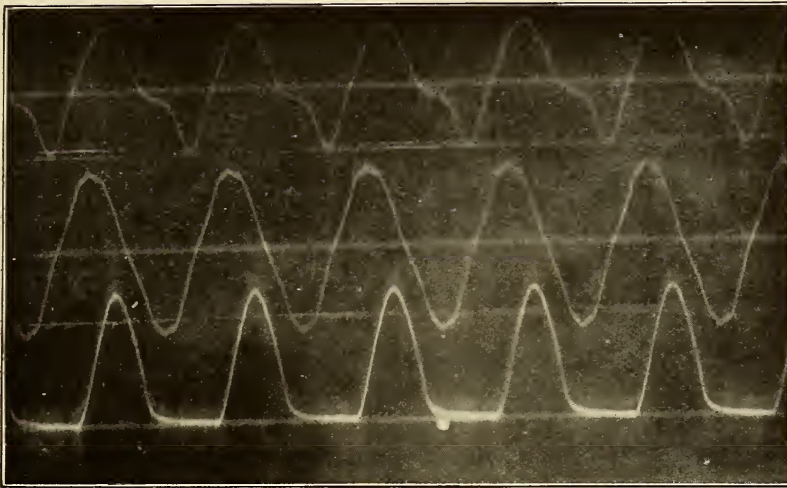

FIG. 47.—Rectified current of a thermionic rectifier

Upper curve represents primary current; middle curve, secondary voltage; and lower curve, rectified current

heavy current required for heating the filament. This is apparent when it is considered that a filament current of 12 amperes is required by rectifier P , and 17 amperes by Q , with no battery load.

The rectified current obtained with rectifier Q is shown in Figure 47, in which it is apparent that rectification is practically perfect, there being no leakage or capacity effect as there were in the case of the electrolytic rectifiers.

The low-power factor, due to wave distortion, is of little consequence to the user, but it may be remedied, if desired, by connecting two rectifiers to the power circuit so that full-wave rectification is obtained.

Equation (9) previously derived for the relation between battery voltage and impressed voltage at maximum output is also

true for the thermionic rectifier, which belongs to the valve type. In Figure 48 the maximum of the output curve is at a battery voltage of 10.5 volts. The peak value of the impressed voltage of the rectifier, as determined by the battery voltage required to reduce the charging current to zero, was 27.1 volts. Substituting

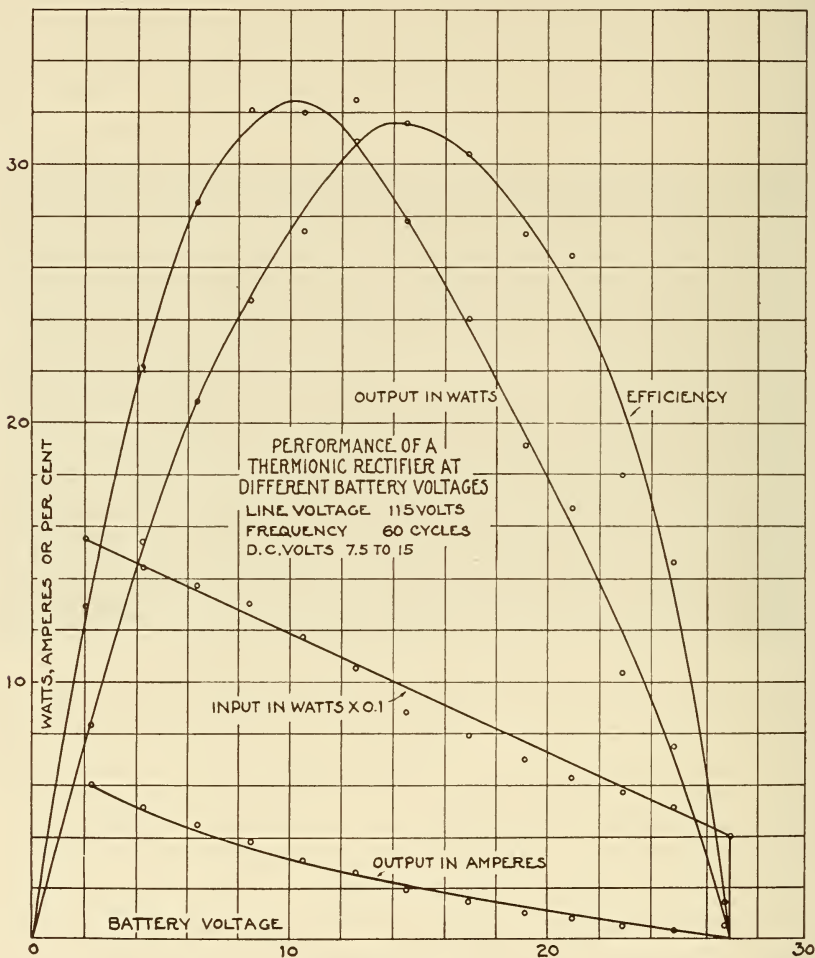

FIG. 48

these values in equation (9) we have $E_B = 10.8$, which shows that this equation closely represents the voltage relation at maximum output. Since the energy efficiency is the ratio of power output to input and the input bears approximately a linear relation to the battery voltage, it is apparent from the curves in Figure 48 why the maximum efficiency is obtained at a battery voltage higher than that at which maximum output is obtained.

While the efficiency of rectifier *P* reaches a slightly higher maximum (34.6 per cent) than rectifier *Q* (31.6 per cent), their efficiencies at their lower current ratings are almost identical. Thus, rectifier *P*, rated at 2 amperes, has an efficiency of 27.2 per cent at 2.01 amperes, and rectifier *Q*, rated at 3 amperes, has an efficiency of 27.4 per cent at 3.05 amperes. As in the case of the other types, thermionic rectifiers should not be chosen on the basis of efficiency alone, inasmuch as other factors, particularly the relation between the current and life of the tube must be considered also.

TABLE 4.—Performance of Thermionic Rectifier P

Line voltage used, 117 volts
 Rating . { Line voltage, 110 volts; frequency, 60 cycles
 { 6 to 12 volts DC, 2 amperes DC

| Primary current | Input | Power factor | Battery voltage | Charging current (average value) | Output | Efficiency |
|-----------------|-------|--------------|----------------------|----------------------------------|--------|------------|
| Amperes | Watts | Per cent | Volts | Amperes | Watts | Per cent |
| 1.85 | 87 | 40 | 2.10 | 3.24 | 6.8 | 7.8 |
| 1.71 | 87 | 44 | 4.25 | 3.02 | 12.8 | 14.8 |
| 1.59 | 83 | 45 | 6.40 | 2.59 | 16.6 | 20.0 |
| 1.46 | 81 | 47 | 8.42 | 2.32 | 19.6 | 24.2 |
| 1.31 | 77 | 50 | 10.40 | 2.01 | 20.8 | 27.2 |
| 1.20 | 75 | 53 | 12.40 | 1.80 | 22.3 | 29.7 |
| 1.07 | 71 | 57 | 14.40 | 1.59 | 22.9 | 32.2 |
| 1.00 | 66 | 56 | 16.80 | 1.32 | 22.1 | 33.5 |
| .91 | 64 | 60 | 18.80 | 1.18 | 22.1 | 34.6 |
| .80 | 60 | 64 | 20.5 | .97 | 19.9 | 33.1 |
| .75 | 56 | 64 | 22.8 | .80 | 18.3 | 32.6 |
| .65 | 54 | 71 | 24.8 | .66 | 16.4 | 31.6 |
| .60 | 52 | 74 | 26.9 | .48 | 12.9 | 24.8 |
| .55 | 48 | 75 | 29.0 | .38 | 11.0 | 23.0 |
| .50 | 43 | 74 | 30.8 | .21 | 6.5 | 15.3 |
| .37 | 37 | 85 | 32.8 | .04 | .13 | 3.6 |
| .34 | 35 | 88 | 34.8 | .00 | .00 | .00 |
| .34 | 35 | 88 | Without battery load | | | |

TABLE 5.—Performance of Thermionic Rectifier Q

Line voltage used, 115 volts.
 Rating . { Line voltage, 115 volts; frequency, 60 cycles.
 { 7.5 to 15 volts DC, and 5 to 3 amperes DC

| Primary current | Input | Power factor | Battery voltage | Charging current | Output | Efficiency |
|-----------------|-------|--------------|----------------------|------------------|--------|------------|
| Amperes | Watts | Per cent | Volts | Amperes | Watts | Per cent |
| 3.50 | 155 | 38 | 2.15 | 6.00 | 12.9 | 8.3 |
| 3.05 | 144 | 41 | 4.28 | 5.15 | 22.1 | 15.4 |
| 2.70 | 137 | 44 | 6.40 | 4.45 | 28.5 | 20.8 |
| 2.40 | 130 | 47 | 8.45 | 3.80 | 32.1 | 24.7 |
| 2.08 | 117 | 49 | 10.48 | 3.05 | 32.0 | 27.4 |
| 1.78 | 105 | 51 | 12.50 | 2.60 | 32.5 | 30.9 |
| 1.40 | 88 | 55 | 14.50 | 1.92 | 27.8 | 31.6 |
| 1.15 | 79 | 60 | 16.90 | 1.42 | 24.0 | 30.4 |
| .90 | 70 | 68 | 19.10 | 1.00 | 19.1 | 27.3 |
| .70 | 63 | 78 | 20.90 | .80 | 16.7 | 26.5 |
| .65 | 57 | 76 | 22.90 | .45 | 10.3 | 18.0 |
| .55 | 51 | 81 | 24.90 | .30 | 7.5 | 14.6 |
| .50 | 40 | 70 | 26.90 | .02 | .54 | 1.4 |
| .39 | 40 | | Without battery load | | | |

The performance curves for the tantalum rectifier and also for the thermionic rectifier are of the same general shape. Similar curves would have been obtained with the aluminum rectifier if the range in battery voltage had been extended to the peak value of the impressed voltage as it was for the other rectifiers.

XIII. DESCRIPTION OF VIBRATING RECTIFIERS

The vibrating rectifier consists of a contactor operated in synchronism with the alternating current to be rectified. When the contactor is allowed to make and break the circuit at the proper points of the wave, pulsations of current occur in the same direction. In the absence of a battery the proper points of operation are 180° apart. Practically, however, this condition is not attained because an appreciable amount of time is required for the contactor to operate. With a single contact, as in Figure 49,

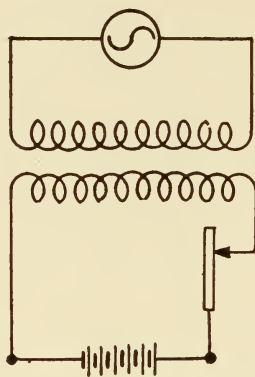

FIG. 49.—Vibrating rectifier for half-wave rectification

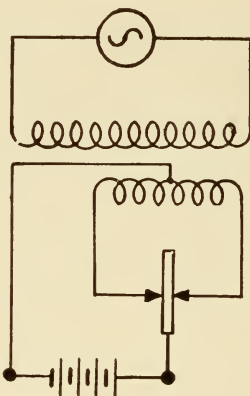

FIG. 50.—Vibrating rectifier for full-wave rectification.

half-wave rectification is obtained, and with a double contact, as in Figure 50, full-wave rectification is obtained. With a battery in the rectified circuit the contactor should close at "C," and open at "D"—that is, when the impressed voltage equals the battery voltage (fig. 51). Otherwise, sparking occurs. If $E_{\max} \sin(\omega t - \alpha)$ is the impressed voltage and E_B is the battery voltage, (when $t = 0$)

$$-E_{\max} \sin \alpha = E_B \text{ or } \sin \alpha = \frac{E_B}{E_{\max}}$$

and the interval from C to D is $(\pi - 2\alpha)$.

The oscillogram in Figure 52 was obtained with a half-wave vibrating rectifier charging a 5-cell battery having a voltage of 11.6. The peak voltage E_{\max} of this rectifier was 20.8. In this case then

$$\sin \alpha = \frac{11.6}{20.8} = 0.558 \text{ or } \alpha = 34^\circ$$

The interval of closure should be $180^\circ - (2 \times 34)$ or 112° , or 31 per cent of the total time. Measurement on the oscillogram in Figure 52 shows that the contactor was closed 32 per cent of the time for this rectifier. An interval of time corresponding to $(\pi + 2\alpha)$ is, therefore, required for the contactor to travel during each reversal of the current. In the case of a full-wave rectifier

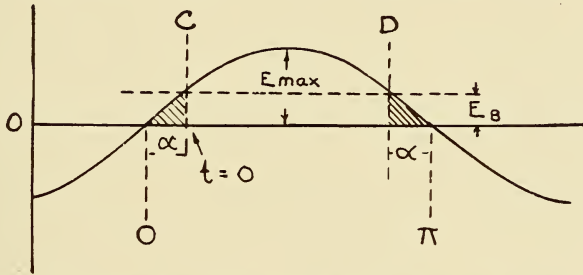

FIG. 51.—Relation between battery voltage and impressed voltage of rectifier

an interval of time corresponding to 2α is required for the contactor to travel between contacts.

The contactor consists of a vibrating member of magnetic material placed in the field of a permanent magnet and actuated by a superimposed alternating field in synchronism with the voltage to be rectified. Synchronism is accomplished by utilizing the same source of current for producing the alternating field as that to be rectified. The alternating field exerts the actuating force, while the permanent field polarizes the magnetic vibrator. The vibrator and permanent magnet are so adjusted that the rectified circuit is open when the rectifier is not in operation. The details of construction vary considerably with different manufacturers. Thus, in the type illustrated by Figure 53, the alternating-current electromagnet is tapped off the secondary, and a condenser is used to balance the inductance of the actuating coil "A" and bring the actuating current more nearly in phase with the voltage at the contact. This type is also made for full-wave rectification, by using two contacts instead of one, and a tap at the middle of the secondary of the transformer (fig. 50). In the type illustrated

in Figure 54 the actuating coil "A" has few turns and its inductance is, therefore, so small that no condenser is necessary to correct for phase shift. In Figure 55 the permanent field is obtained by using a DC electromagnet supplied by the battery being charged. This rectifier, therefore, draws some current from the battery continuously whether or not the rectifier is operating. One advantage of this type is that the polarity of

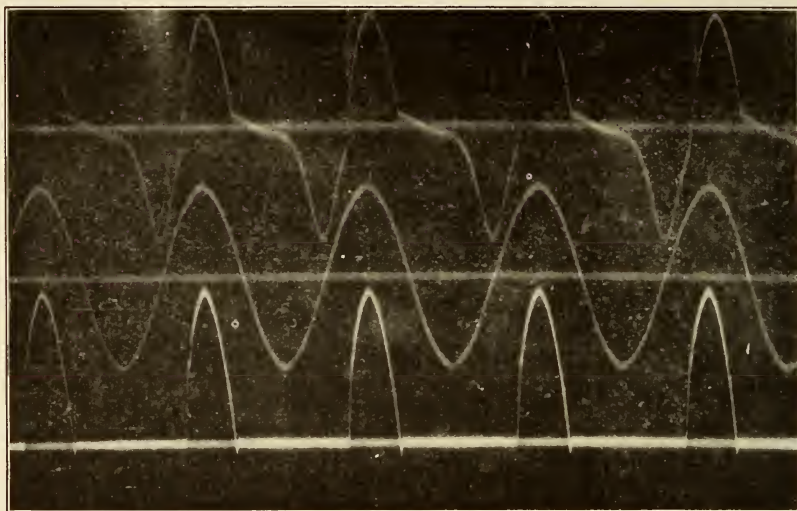

FIG. 52.—Rectified current of rectifier B

Upper curve represents primary current; middle curve, secondary voltage; and lower curve, rectified current

the rectifier is dependent on the battery so that no error can be made in accidentally reversing the connection terminals.

XIV. PERFORMANCE TESTS OF VIBRATING RECTIFIERS

The performance of five different vibrating rectifiers was studied. These rectifiers are denoted by letters of the alphabet in Table 6, which gives the rating of each type. Rectifier "A" was designed for delivering comparatively large currents, such as are required for charging the batteries for supplying filament current in radio tubes, and for automobile batteries, while the other rectifiers here described were designed for delivering small currents, such as are required for charging railway signal and track batteries. Since these rectifiers were designed for different purposes, a comparison of their performance on the same basis is not fair, without keeping these differences in mind. The performance curves for rectifier "A" are given along with the others as a matter of convenience,

and for the reasons stated, a literal comparison between its performance and that of the other types should not be made. Rectifier "A" belonged to the type indicated in Figure 55 and had a fixed resistance unit to limit the current. The vibrating member of rectifier "A" was a stiff spring rigidly clamped at one end and carrying a soft iron bar and contact on the other end. Rectifiers "B" and "C" were alike except for the differences noted in the table. They belonged to the type indicated in Figure 53 and had

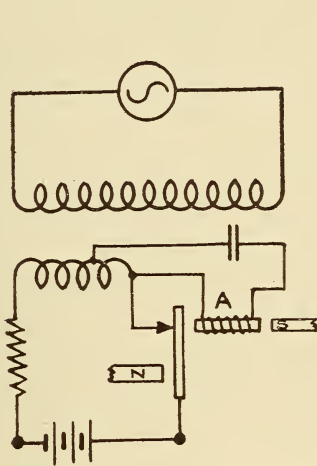

FIG. 53.—Vibrating rectifier in which a condenser is used to balance the inductance of the electromagnet and bring the actuating current more nearly in phase with the voltage to be rectified

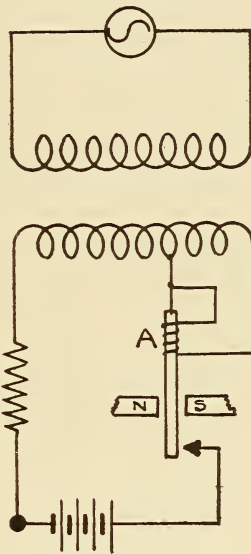

FIG. 54.—Vibrating rectifier in which inductance of electromagnet is so small that no condenser is necessary

two pairs of fixed resistances to limit the charging rate, one pair to be used for charging one cell (track cell) and the other pair to be used for charging five cells (signal battery). The vibrating member of these rectifiers was a swinging armature with spring contact, actuated by two electromagnets. The permanent field was supplied by a bar magnet.

TABLE 6.—Ratings of Vibrating Rectifiers

| Sample | A | B | C | D | E |
|-----------------------|------------|------------|------------|------------|------------|
| Rectification..... | Half-wave. | Half-wave. | Full-wave. | Half-wave. | Half-wave. |
| Line voltage..... | 110 | 110-115 | 110-115 | 100-115 | 100-115 |
| Frequency..... | 60 | 60 | 60 | 60 | 60 |
| Battery voltage..... | 6 | 2-10 | 10 | 2-10 | 2-12 |
| Charging current..... | 5 | 0.5-1.0 | 1-2 | 0.5-1.0 | 0.5-1.0 |

Rectifier "D" belonged to the type indicated in Figure 54 and was provided with a sliding rheostat for adjusting the charging current. The two values of current output given in Table 7 were the maximum (0.51) and minimum (0.074) values obtained by adjustment of the rheostat. The vibrating member was supported

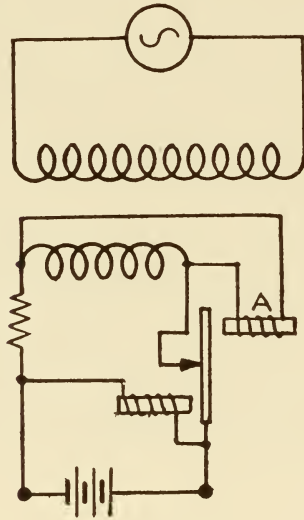

FIG. 55.—Vibrating rectifier in which the permanent magnetic field is supplied by an electromagnet energized by the battery being charged

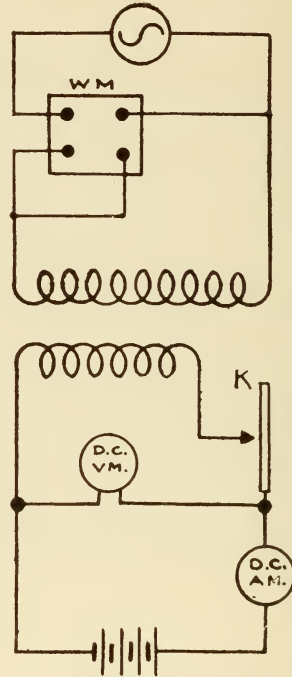

FIG. 56.—Method of measuring output and efficiency of a rectifier

in the field of a U shape magnet, by means of a stiff spring clamped at one end.

Rectifier "E" belonged to the type indicated in Figure 53 and was provided with a rheostat for adjustment of current and also with a fuse in the battery circuit. Its vibrating member also consisted of a stiff spring firmly clamped in the field of a U shape magnet.

Variation in the distance between contacts (0.010 to 0.025 inch) and slight adjustments of the vibrating members could be made to obtain sparkless operation.

Since all the vibrating rectifiers tested were provided with either fixed or variable resistances for limiting the charging current, a

statement of the efficiency involves the question as to whether the I^2R loss in such resistance should be credited to the output of the rectifier. In all tests, however, the output was measured at the terminals of the rectifier to which the battery was connected. The efficiency, thus measured, increased as such resistance was reduced, as shown in Table 7, for rectifiers D and E, for currents obtained with minimum and maximum resistance, respectively.

In judging the performance of rectifiers several factors must be taken into account, and all of these are not susceptible to measurement. In the case of vibrating rectifiers, the reliability and the maintenance requirements are of prime importance particularly in railway service. A determination of these factors would require life tests under service conditions covering a long period of time. The tests here described were limited to the electrical performance within a reasonable range in conditions of line voltage, frequency, and battery voltage. While the energy efficiency is not of the greatest importance in the operation of these rectifiers in which the power concerned is comparatively small, it serves as a direct measure of the performance of the rectifier. With the arrangement in Figure 56 the energy efficiency was readily determined from the power input indicated by the wattmeter and the power output computed as the product of the battery voltage and the charging current.

A summary of the results of tests is given in Table 7 for the five vibrating rectifiers operated under the conditions for which they were rated by the manufacturers. The no-load losses were indicated by the wattmeter (fig. 56) when no battery was connected to the rectifier. The results for one cell in the case of rectifiers B, C, and E were obtained with the cell connected to the "track" terminals—that is, in series with a different resistance and on different transformer tap, than in the case of the signal batteries of five or six cells.

The efficiency of rectifier A is the highest (43 per cent) in spite of the large no-load loss (30 watts). This is probably due to the low I^2R loss, which, in turn, is due to the low resistance necessary to limit the current to about 5 amperes. The efficiency of rectifiers D and E having adjustable resistances increase as the resistance is reduced. Their efficiency, of course, may be further increased by reducing the resistance still further, but the increase in current is limited by the current-carrying capacity of the contacts.

Since there is no appreciable phase difference between the input voltage and current as shown by the oscillogram, the low power factor is due to wave distortion. No measurements of the phase angle and I^2R losses (copper loss) of the transformers were made. The no-load losses in Table 7 represent practically the core losses of the transformer.

TABLE 7.—Performance Data of Vibrating Rectifiers

| Rectifier | No-load loss | Line voltage (AC) | Input current (AC) | Input | Cells | Battery voltage (DC) | Output current (DC) | Output | Efficiency | Power factor |
|-----------|--------------|-------------------|--------------------|-------|-------|----------------------|---------------------|--------|------------|--------------|
| | Watts | Volts | Amperes | Watts | | Volts | Amperes | Watts | Per cent | Per cent |
| A..... | 30 | 110 | 1.20 | 81 | 3 | 7.10 | 4.90 | 34.8 | 43.0 | 61 |
| B..... | 1.2 | 115 | .055 | 5.30 | 1 | 2.32 | .57 | 1.32 | 24.9 | 84 |
| | | 115 | .182 | 11.62 | 5 | 10.75 | .37 | 3.98 | 34.3 | 56 |
| C..... | 3.6 | 115 | .115 | 9.80 | 1 | 2.36 | 1.28 | 3.02 | 31.0 | 74 |
| | | 115 | .255 | 23.6 | 5 | 10.80 | .84 | 9.08 | 38.5 | 80 |
| D..... | 2.4 | 110 | .219 | 13.76 | 5 | 10.05 | .51 | 5.13 | 37.3 | 57 |
| | | 110 | .040 | 4.08 | 5 | 10.20 | .074 | .76 | 18.6 | 93 |
| E..... | .8 | 110 | .101 | 6.60 | 1 | 2.12 | .86 | 1.84 | 27.9 | 59 |
| | | 110 | .040 | 3.40 | 1 | 2.05 | .10 | .20 | 5.9 | 77 |
| | | 110 | .241 | 13.8 | 6 | 12.28 | .45 | 5.52 | 40 | 52 |
| | | 110 | .07 | 5.60* | 6 | 12.32 | .10 | 1.23 | 22 | 73 |

Variations of the efficiency with frequency, line voltage and battery voltage are shown in Figures 57, 58, and 59, respectively.

In Figure 57 it is apparent that the range in frequency over which rectifier A operates efficiently is very short. It ceased to rectify at 58 cycles. All four of the other rectifiers are more nearly independent of variations in frequency. In the case of rectifier D, particularly, the efficiency is practically independent of variation in frequency from about 45 to 66 cycles, or 25 per cent below and 10 per cent above the rated frequency of 60 cycles.

In Figure 58, which shows the variation of efficiency with line voltage, it is interesting to note that the efficiency increases somewhat as the line voltage is reduced in the case of all the rectifiers. The effect of reducing the line voltage is obviously the same as that of increasing the battery voltage. When the voltage is too low the alternating field becomes too weak to keep the vibrator in vibration and rectification ceases.

In Figure 59, which shows the relation between efficiency and battery voltage, the maximum efficiency was obtained at a battery voltage of 15 volts for rectifiers B, C, and E, and 12.5 volts for D. Rectifier A operated over a very short range in battery voltage. It was designed especially for a 6-volt battery, for which its

efficiency is high. The maxima of the efficiency curves were obtained at battery voltages somewhat higher than the maxima of the power output curves shown in Figure 60. The reason for

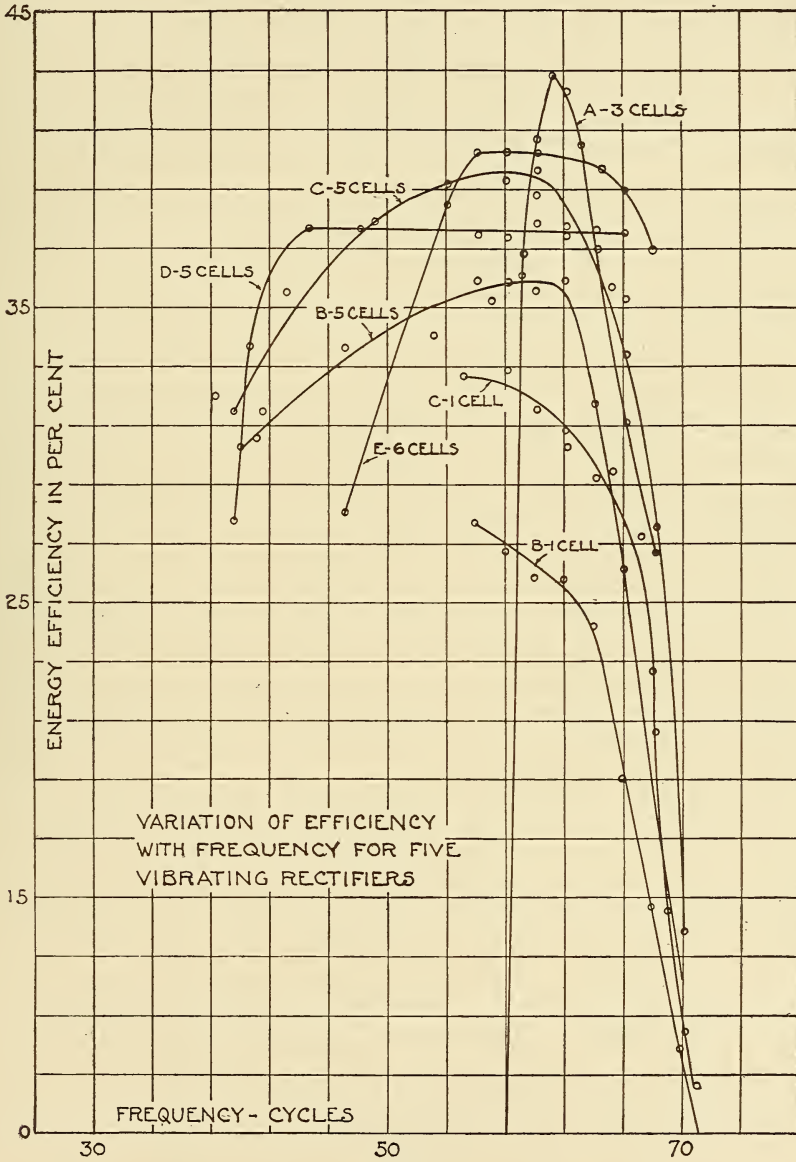

FIG. 57

this is the same as that pointed out in the case of the tantalum rectifier. The maxima of the power output curves were obtained at about one-half the peak voltages, and they are at approximately the rated DC voltages of the rectifier.

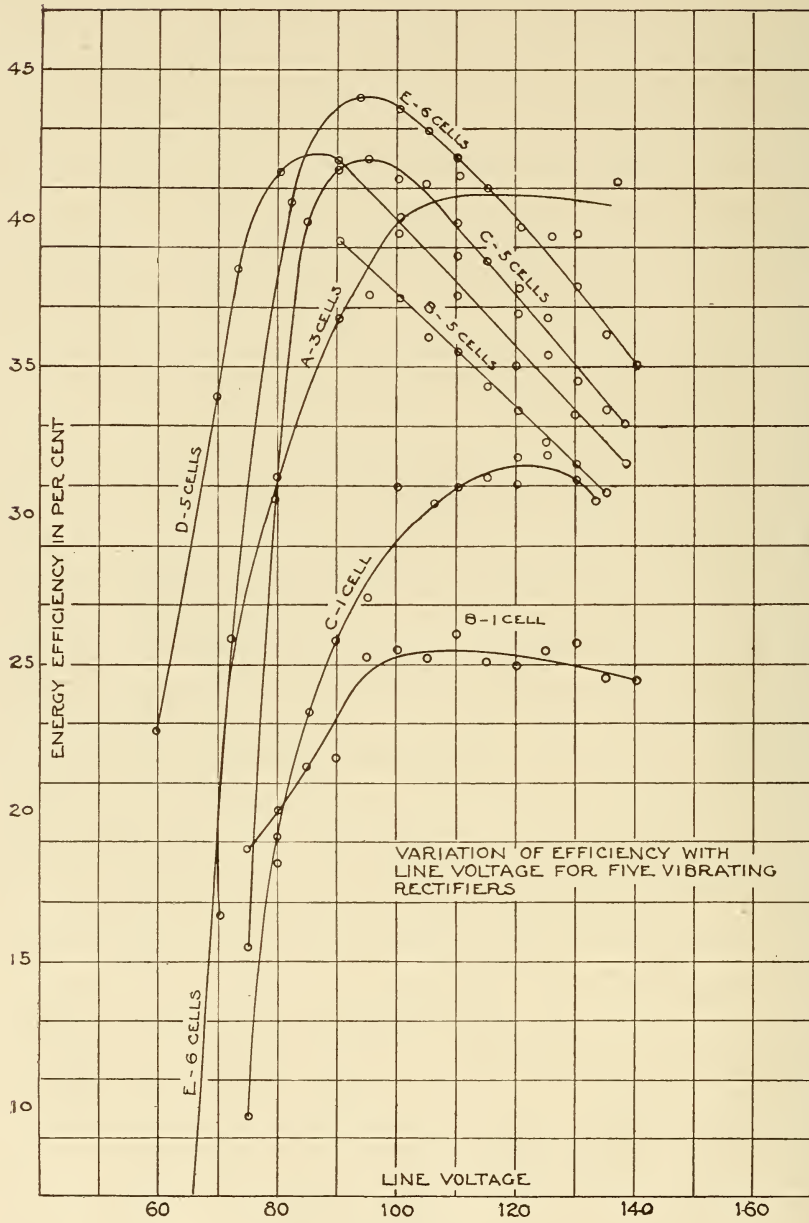

FIG. 58

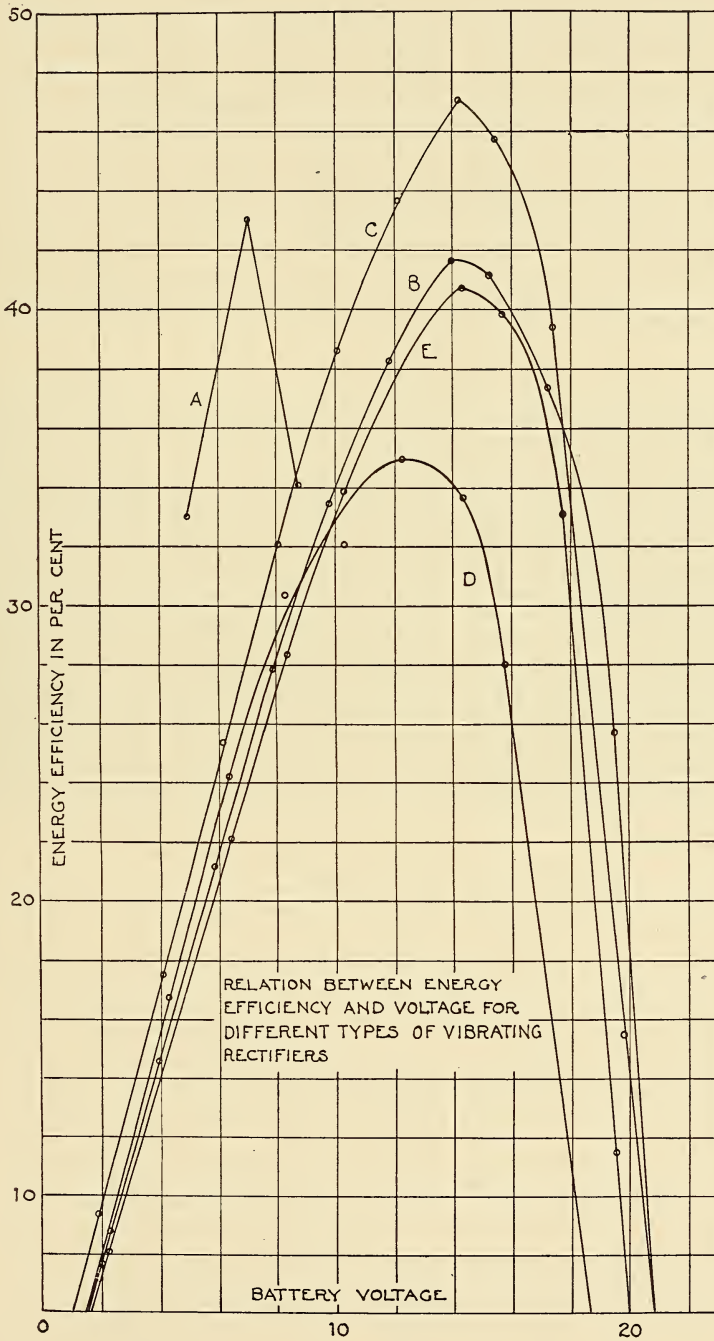

FIG. 59

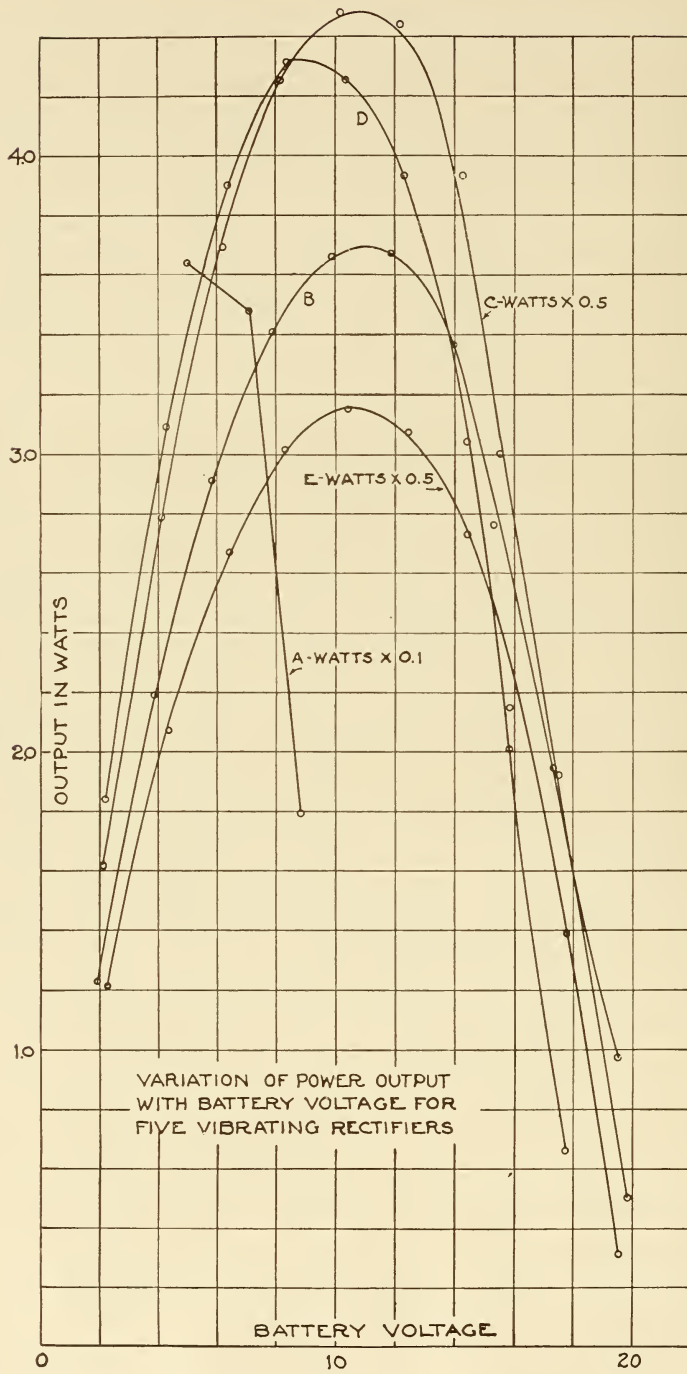

FIG. 60

Equation (9), which was developed for use with rectifiers of the valve type, can not be applied directly to the vibrating rectifiers because at the higher battery voltages the battery discharges for an appreciable time for a given adjustment of contacts, as is shown in Figure 61.

An essential difference between the operation of the vibrating rectifier on the one hand and the valve (electrolytic and ionized gas) rectifier on the other is that the latter type responds instantly to the reversal of the alternating voltage while the former requires an appreciable time. The longer time required by the vibrating type to respond to reversal of voltage does not lower its efficiency,

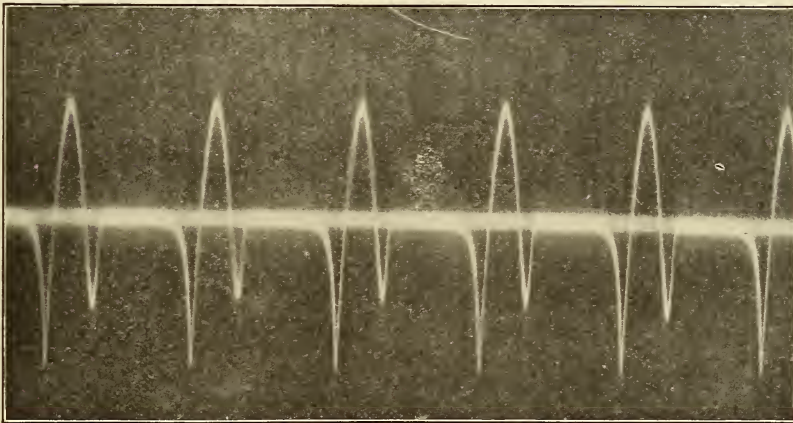

FIG. 61.—Oscillogram showing counter-current through vibrating rectifier when battery voltage is too high

for the reason that in either type charging current can not flow until the impressed voltage equals the battery voltage. This interval of time, which is the same regardless of the type of rectifier, while the impressed voltage is less than the battery voltage, is made use of by the vibrating member in traveling between contacts, which must be adjusted to close and open at the instant that the impressed voltage reaches the battery voltage (fig. 51).

In Figure 62 the battery voltage is plotted against charging current, and extrapolation of the curves to the voltage axis gives the peak voltages of the rectifiers.²⁰ Thus, rectifiers B and C were unable to force current through a battery having a voltage above 20.3 volts, D above 18.3 volts, and E above 20 volts

²⁰ Since the completion of this work an article by R. D. Mershon has appeared in the Jour. Amer. Inst. Elect. Eng., 43, p. 156 (1924), describing the use of a rectifier for measuring peak voltage.

The wave forms of the primary current, secondary voltage, and the rectified currents are shown in Figures 52, 63, 64, 65, and 66 for rectifiers A, B, C, D, and E, respectively. There is no leak-

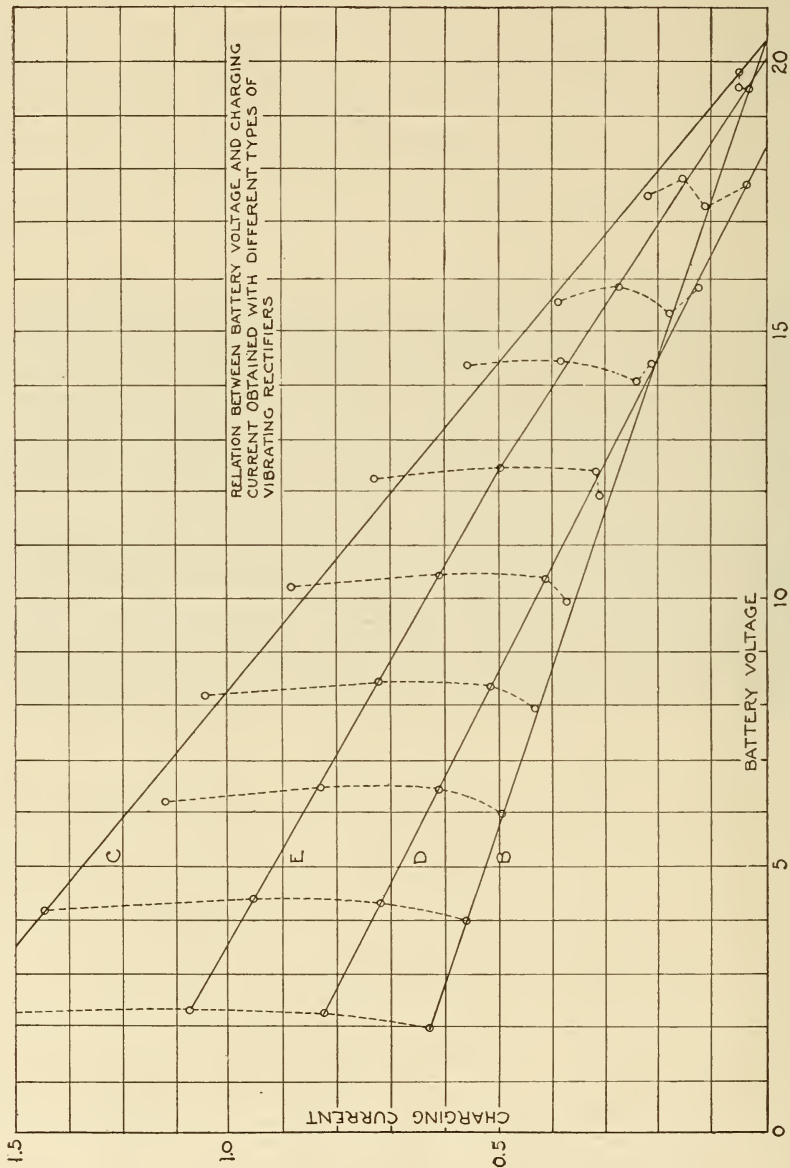

FIG. 62

age or capacity effect in these rectifiers when operating under their rated conditions. The leakage current, however, is appreciable when the frequency is considerably different from 60 cycles (fig. 67), and also when the battery voltage is too high (fig. 61).

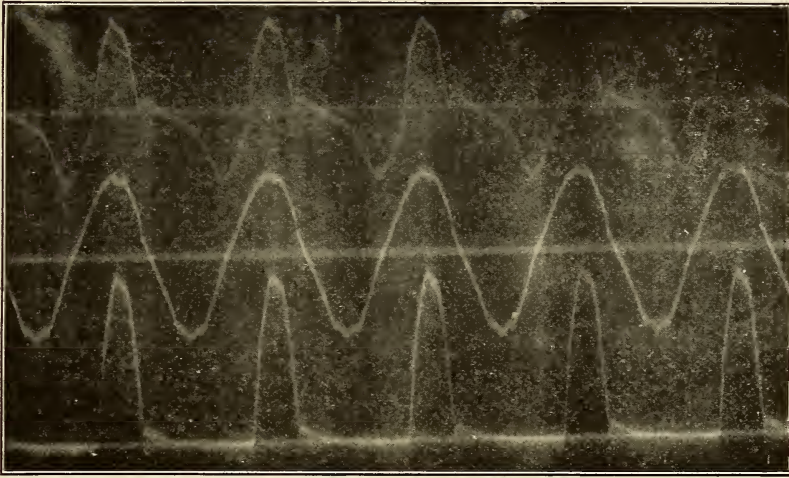

FIG. 63.—*Rectified current of rectifier A*

Upper curve represents primary current; middle curve, secondary voltage; and lower curve, rectified current

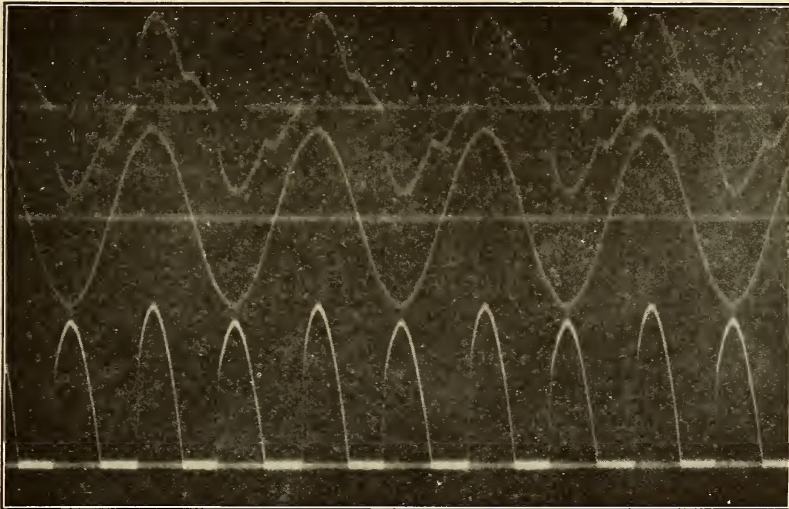

FIG. 64.—*Rectified current of rectifier C*

Upper curve represents primary current and middle curve, secondary voltage

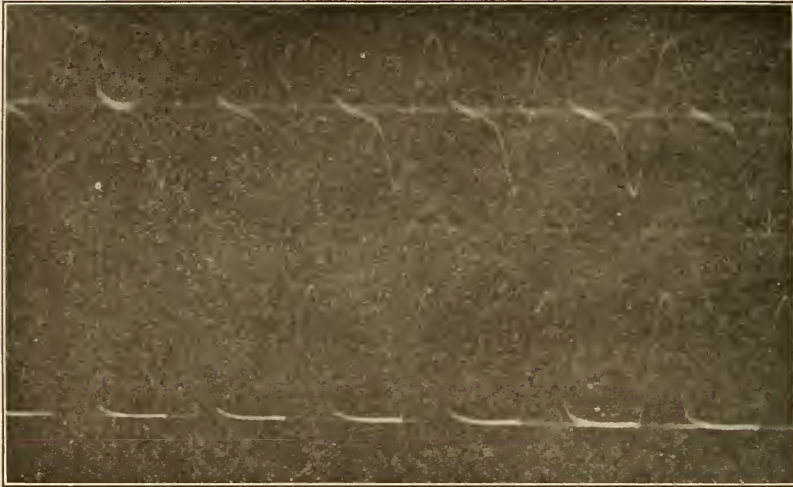

FIG. 65.—*Rectified current of rectifier D*

Upper curve represents primary current; middle curve, secondary voltage; and lower curve, rectified current

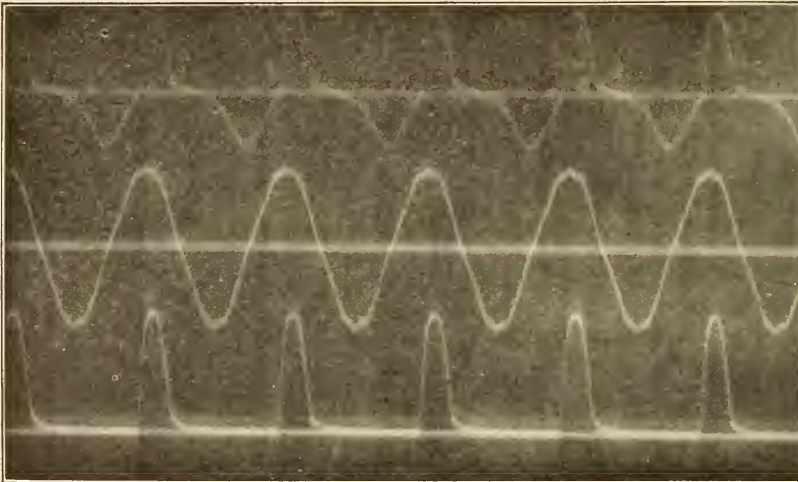

FIG. 66.—*Rectified current of rectifier E*

Upper curve represents primary current; middle curve, secondary voltage; and lower curve, rectified current

The performance of a rectifier at different frequencies depends upon the relation between the natural period of the vibrator and the frequency of the impressed alternating voltage. This may be apparent from the following considerations which have been partially discussed by Schüler.²¹

As pointed out in Figure 51, the rectifying circuit must be closed at *C* and opened at *D* when the instantaneous values of the alternating voltage are equal to the battery voltage. The swinging armature or vibrating spring, as the case may be, must keep in

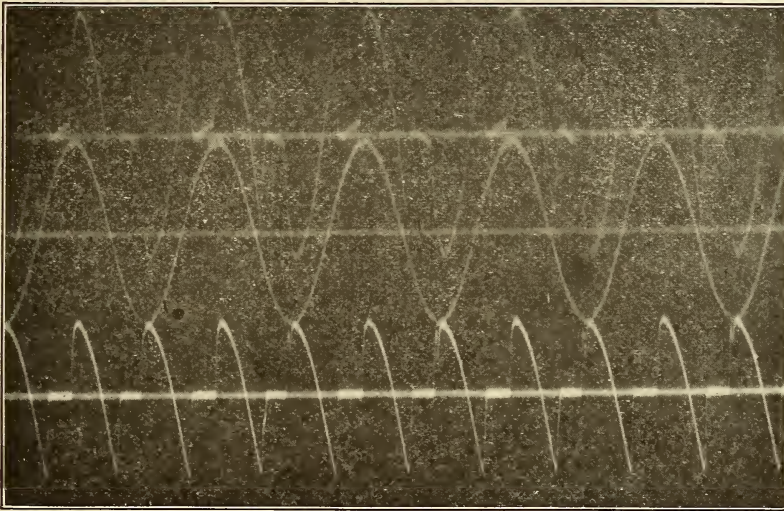

FIG. 67.—Rectified current at 70 cycles of a vibrating rectifier designed for 60 cycles
Upper curve represents primary current; middle curve, secondary voltage; and lower curve, rectified current

phase with the voltage. The displacement of the vibrator at any instant is produced by the force exerted by the alternating field, which is approximately proportional to and in phase with the actuating current in the electromagnet. To bring the vibration in phase with the voltage, both the electrical phase difference between the voltage and current and the mechanical phase difference between the force and displacement must be considered. Furthermore, both the electrical and mechanical phase differences vary with the frequency.

In such a vibrating system the relations between frequency, displacement, and phase are shown by the well-known curve in

²¹ *Elektrotech. Zeit.*, 42, pp. 481-483; 1921.

Figure 68 where displacement is plotted against frequency. When the frequency is such that the force (and, therefore, the current in the electromagnet) is in phase with the velocity of motion, maximum displacement is obtained and the frequency at this point is the natural or resonant frequency. Since displacement leads the

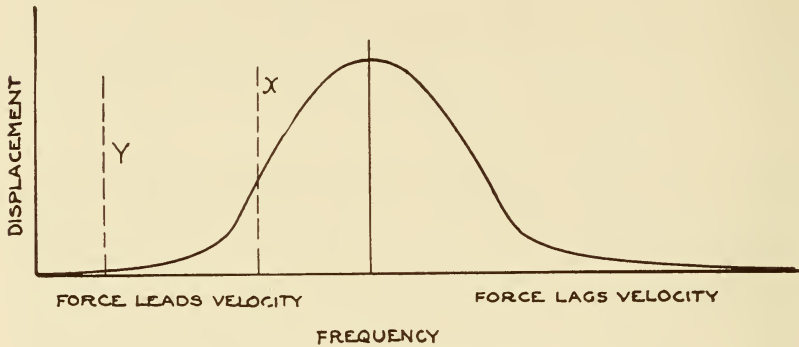

FIG. 68.—Resonance curve

velocity by 90° , vibration at the natural frequency does not necessarily fulfill the requirement for rectification. For example, assuming that the current (and, therefore, the force) is in phase with the voltage, then at resonance the displacement (always leading velocity by 90°) leads the voltage 90° . Under this con-

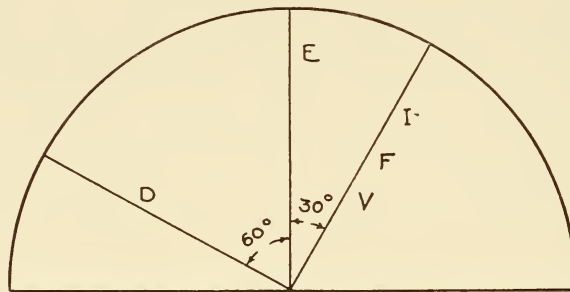

FIG. 69.—Phase relation between voltage E and displacement D at resonance, when the actuating current I lags E by 30°

(Displacement D always leads velocity by 90°)

dition, the circuit would be closed at the peak of the wave and no rectification could be obtained. If the current lags the voltage 90° then at resonance the displacement would be in phase with the voltage and rectification would be obtainable.

As a further example, if the current I lags the voltage E , say 30° , due to the inductance of the electromagnet, then at resonance the displacement D (fig. 69) leads the voltage E by 60° and prac-

tically no rectification is obtainable. In order to obtain rectification in this case, the frequency used should be lower than the resonance value. By using the frequency corresponding to x (fig. 68) when the force leads the velocity by 60° , the displacement

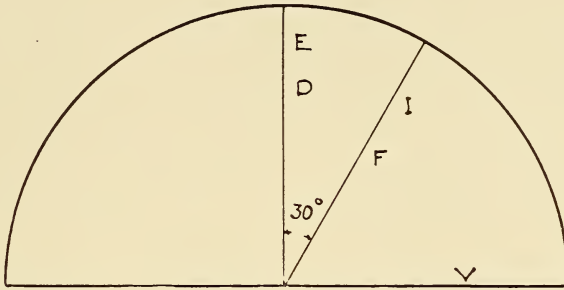

FIG. 70.—When the current I lags voltage E by 30° , the displacement D may be brought in phase with E by using a frequency at which force F leads velocity V by 60°
(Displacement D leads velocity by 90°)

would be in phase with the voltage (fig. 70) and rectification would be obtainable.

If the current I is in phase with the voltage (fig. 71), the displacement D may be brought in phase with the voltage by using a frequency corresponding to the condition when the force leads the velocity 90° , as indicated by the line Y (fig. 68). Over this flat

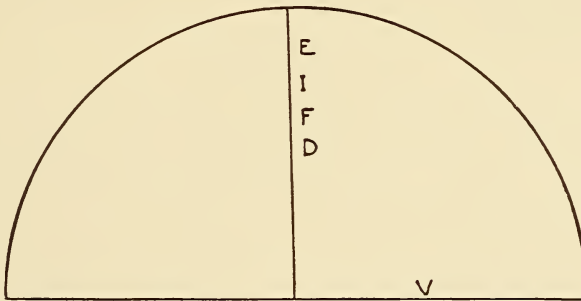

FIG. 71.—When the voltage E and current I are in phase, the displacement D may be brought in phase with E by using a frequency at which the force F leads velocity V by 90°
(Displacement D leads velocity V by 90°)

portion of the curve displacement is almost independent of frequency. It is apparent, therefore, that an armature which is forced to vibrate, at a frequency far different from its resonance frequency, is more independent of variations in frequency than one which is operated near its natural period.

For a lagging current a frequency below resonant frequency should be used, and for a leading current a frequency above resonance is necessary to obtain rectification. As previously

mentioned, a condenser is sometimes used to compensate for the inductance of the electromagnet. As the current and voltage become more nearly in phase, the further the frequency necessary for rectification is removed from resonance. The resonance frequency may also be considerably raised by using a stiffer spring, and by using a stronger permanent field as the controlling force. As the controlling force is increased, more current is required by the electromagnet to produce vibration and the energy efficiency

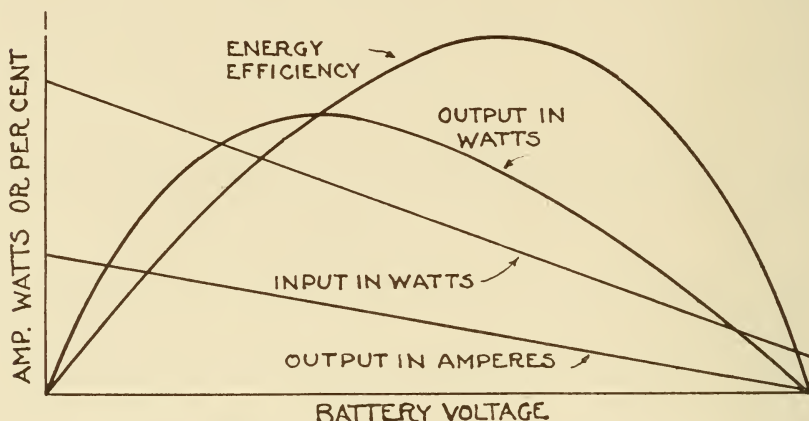

FIG. 72.—Performance curves of a rectifier

is reduced, but greater independence of variation in frequency is thereby obtained.

XV. SUMMARY

The theory and performance of various types of small rectifiers were studied, including the aluminum and tantalum electrolytic rectifiers, thermionic rectifiers, and vibrating rectifiers. The wave form of the rectified current, the degree of rectification, and the energy efficiency of these rectifiers were determined under a variety of conditions. In order to explain the results obtained it was necessary to develop the theory of rectification as it occurs during the process of charging the battery.

In the case of electrolytic rectifiers, the degree of rectification and energy efficiency were increased by using high-current densities and inductance in series. Their performance curves are very similar in shape to those of the ionized gas rectifier, although, of course, their numerical relations are different. The performance of both these rectifiers may be represented by a typical set of curves as in Figure 72. The relation between power output and battery voltage may be represented by an equation from which the battery voltage for maximum output may be computed. The

computed value of the battery voltage at maximum output agrees with the observed value, which is approximately the voltage rated by the manufacturers.

The performance of the vibrating rectifiers was determined from their output and efficiency for various values of line voltage, frequency and battery voltage. Their performance curves are similar to those of the electrolytic and ionized gas rectifiers as illustrated in Figure 72. The battery voltage for maximum output, however, can not be so readily calculated because the vibrator requires an appreciable time to operate at each reversal of the alternating voltage, while the electrolytic and ionized gas rectifiers respond instantaneously.

WASHINGTON, January 29, 1924.

